

***TECHNICAL MANUAL***  
***Of***  
***Intel Pine Trail D & ICH8M Chipset***  
***Based***  
***Mini-ITX M/B for ATOM Processor***

NO.G03-NF96-F

**Revision: 6.0**

Release date: November, 2010

**Trademark:**

- \* Specifications and Information contained in this documentation are furnished for information use only, and are subject to change at any time without notice, and should not be construed as a commitment by manufacturer.

---

---

## Environmental Protection Announcement

Do not dispose this electronic device into the trash while discarding. To minimize pollution and ensure environment protection of mother earth, please recycle.



---

---

# **TABLE OF CONTENT**

ENVIRONMENTAL SAFETY INSTRUCTION.....	iii
USER'S NOTICE .....	iv
MANUAL REVISION INFORMATION.....	iv
ITEM CHECKLIST .....	iv
<b>CHAPTER 1 INTRODUCTION OF THE MOTHERBOARD</b>	
1-1 FEATURE OF MOTHERBOARD.....	1
1-2 SPECIFICATION .....	2
1-3 LAYOUT DIAGRAM.....	3
<b>CHAPTER 2 HARDWARE INSTALLATION</b>	
2-1 JUMPER SETTING .....	7
2-2 CONNECTORS AND HEADERS.....	11
2-2-1 CONNECTORS .....	11
2-2-2 HEADERS .....	12
<b>CHAPTER 3 INTRODUCING BIOS</b>	
3-1 ENTERNING SETUP.....	20
3-2 GETTING HELP .....	20
3-3 THE MAIN MENU.....	20
3-4 STANDARD BIOS FEATURES .....	22
3-5 ADVANCED BIOS FEATURES .....	24
3-5-1 CPU FEATURE .....	26
3-6 ADVANCED CHIPSET FEATURES .....	27
3-7 INTEGRATED PHERIPHRALS .....	28
3-7-1 ONBOARD SATA FUNCTION .....	29
3-7-2 ONBOARD DEVICE FUNCTION.....	30
3-7-3 ONBOARD SUPER IO FUNCTION.....	31
3-8 POWER MANAGEMENT SETUP.....	32
3-9 PNP/PCI CONFIGURATIONS.....	33
3-10 PC HEALTH STATUS.....	34
3-11 MISCELLANEOUS CONTROL.....	36
3-12 PASSWORD SETTING .....	37
3-13 LOAD OPTIMIZED /STANDARDDEFAULTS .....	38
3-14 SAVE AND EXIT SETUP/EXIT WITHOUT SAVING .....	38



## Environmental Safety Instruction

---

- Avoid the dusty, humidity and temperature extremes. Do not place the product in any area where it may become wet.
- 0 to 60 centigrade is the suitable temperature. (The figure comes from the request of the main chipset)
- Generally speaking, dramatic changes in temperature may lead to contact malfunction and crackles due to constant thermal expansion and contraction from the welding spots' that connect components and PCB. Computer should go through an adaptive phase before it boots when it is moved from a cold environment to a warmer one to avoid condensation phenomenon. These water drops attached on PCB or the surface of the components can bring about phenomena as minor as computer instability resulted from corrosion and oxidation from components and PCB or as major as short circuit that can burn the components. Suggest starting the computer until the temperature goes up.
- The increasing temperature of the capacitor may decrease the life of computer. Using the close case may decrease the life of other device because the higher temperature in the inner of the case.
- Attention to the heat sink when you over-clocking. The higher temperature may decrease the life of the device and burned the capacitor.

---

---

## USER'S NOTICE

COPYRIGHT OF THIS MANUAL BELONGS TO THE MANUFACTURER. NO PART OF THIS MANUAL, INCLUDING THE PRODUCTS AND SOFTWARE DESCRIBED IN IT MAY BE REPRODUCED, TRANSMITTED OR TRANSLATED INTO ANY LANGUAGE IN ANY FORM OR BY ANY MEANS WITHOUT WRITTEN PERMISSION OF THE MANUFACTURER.

THIS MANUAL CONTAINS ALL INFORMATION REQUIRED TO USE THIS MOTHER-BOARD SERIES AND WE DO ASSURE THIS MANUAL MEETS USER'S REQUIREMENT BUT WILL CHANGE, CORRECT ANY TIME WITHOUT NOTICE. MANUFACTURER PROVIDES THIS MANUAL "AS IS" WITHOUT WARRANTY OF ANY KIND, AND WILL NOT BE LIABLE FOR ANY INDIRECT, SPECIAL, INCIDENTAL OR CONSEQUENTIAL DAMAGES (INCLUDING DAMAGES FOR LOSS OF PROFIT, LOSS OF BUSINESS, LOSS OF USE OF DATA, INTERRUPTION OF BUSINESS AND THE LIKE).

PRODUCTS AND CORPORATE NAMES APPEARING IN THIS MANUAL MAY OR MAY NOT BE REGISTERED TRADEMARKS OR COPYRIGHTS OF THEIR RESPECTIVE COMPANIES, AND THEY ARE USED ONLY FOR IDENTIFICATION OR EXPLANATION AND TO THE OWNER'S BENEFIT, WITHOUT INTENT TO INFRINGE.

## Manual Revision Information

Reversion	Revision History	Date
6.0	Sixth Edition	November, 2010

## Item Checklist

- Motherboard
- Motherboard User's Manual
- DVD for motherboard utilities
- Cable(s)
- I/O Back panel shield

---

---

# Chapter 1

## Introduction of the Motherboard

### 1-1 Feature of motherboard

- Intel Pine Trail D and ICH8M chipset.
- Onboard Intel Atom CPU, with low power consumption never denies high performance.
- Support FSB 667 MHz.
- Support DDRII DIMM 667/800 up to 4GB.
- Support PCI slot and mini-PCIE slot
- Onboard Realtek RTL 8111DL Gigabit Ethernet LAN.
- Integrated ALC662 6-channel HD audio CODEC.
- Support USB2.0 data transport demands.
- Support RS232/422/485 and watchdog.

## 1-2 Specification

Spec	Description
<b>Design</b>	<ul style="list-style-type: none"><li>● Mini-ITX form factor; PCB size: 17.0x17.0cm</li></ul>
<b>Chipset</b>	<ul style="list-style-type: none"><li>● Intel Pine Trail D+ICH8M</li></ul>
<b>Embedded CPU</b>	<ul style="list-style-type: none"><li>● <b>Intel Atom CPU</b></li></ul>
<b>Memory Socket</b>	<ul style="list-style-type: none"><li>● 240-pin DDRII DIMM slot x2</li><li>● Support DDRII 667/800 MHz DDRII memory modules</li><li>● Expandable to 4 GB</li></ul>
<b>Expansion Slot</b>	<ul style="list-style-type: none"><li>● 32-bit PCI slot x 1</li><li>● Mini-PCIE slot x1</li></ul>
<b>Integrate IDE and SATAII</b>	<ul style="list-style-type: none"><li>● One PCI IDE controller that supports PCI Bus Mastering, ATA PIO/DMA and the ULTRA DMA 100/66 functions that deliver the data transfer rate up to 100 MB/s</li><li>● Support 2* internal serial ATAII 3 Gb/s connectors and 1* external serial ATAII 3 Gb/s connector</li></ul>
<b>LAN</b>	<ul style="list-style-type: none"><li>● Integrated Realtek RTL8111DL PCI-E Gigabit LAN</li><li>● Support Fast Ethernet LAN function of providing 10Mb/100Mb/1000Mb Ethernet data transfer rate</li></ul>
<b>Audio</b>	<ul style="list-style-type: none"><li>● ALC662 6-channel Audio Codec integrated</li><li>● Audio driver and utility included</li></ul>
<b>BIOS</b>	<ul style="list-style-type: none"><li>● AMI 8MB DIP Flash ROM</li></ul>
<b>Multi I/O</b>	<ul style="list-style-type: none"><li>● Serial port connector x1</li><li>● VGA port connector x1</li><li>● USB port connector x5 and USB header x2</li><li>● ESATA Connector x1</li><li>● RJ-45 LAN connector x1</li><li>● PS/2 keyboard connector x1</li><li>● Audio connector x3 (Line-in, Line-out, MIC)</li><li>● Parallel port header x1</li><li>● Serial port header x1 and RS232/422/RS485 header x1</li><li>● LVDS header x1 and LVDS inverter x1</li></ul>

- GPIO header x1
- LPC header x1
- Front panel audio header x1
- SPDIF\_OUT header x1

## 1-3 Layout Diagram

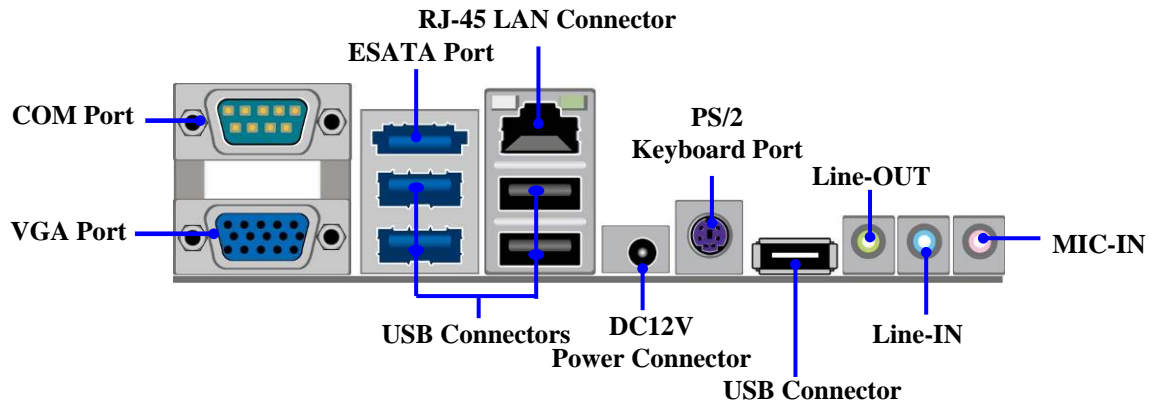

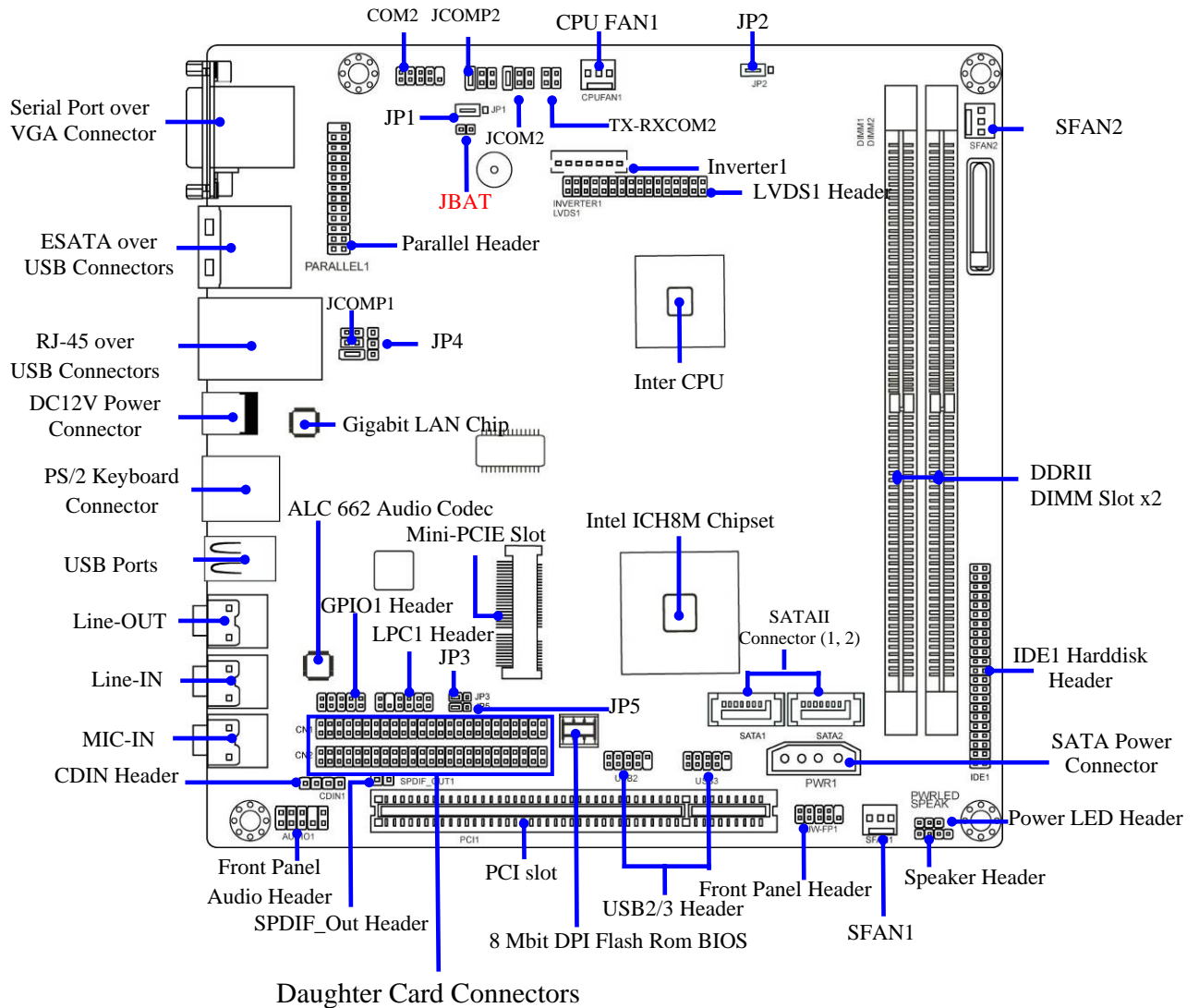

---

---

## ***Jumper***

<b>Jumper</b>	<b>Name</b>	<b>Description</b>
JP1	Inverter 12V/5V Select	3-pin Block
JP2	LVDS PVCC 5V/3.3V Select	3-pin Block
JP3	Mini PCI-E Power Dual 3.3V/VCC3.3V	3-Pin Block
JP4	K/B, USB Power On Function Setting	3-pin Block
JP5	USB 2/3 Power On Function Setting	3-pin Block
JCOMP1	Power RS232 Function Select	6 pin Block
JCOMP2	Power RS232 Function Select	6 pin Block
JCOM2	COM2 RS232/422/485 Function Select	6 pin Block
JBAT	CMOS RAM Clear Function Setting	2-pin Block

## ***Connectors***

<b>Connector</b>	<b>Name</b>	<b>Description</b>
COM1	Serial Port COM Connector	9-pin Connector
VGA	Video Graphic Attach Connector	15-pin Female
USB from US1,UL1;USB1	USB Port Connectors	4-pin Connectors
ESATA from US1	Serial ATAll Connector	7-pin Connectors
LAN from UL1	RJ-45 LAN Connectors	8-pin Connectors
DC12V_IN	DC Power Connector	DC Jack
KB	PS2 Keyboard Connector	6-pin Female
AUDIO2	Line Out /Line In /MIC Audio Connector	3-phone Jack
PWR1	Power out Connector	4-pin Connector
SATA1,SATA2	Serial ATAll Connectors	7-pin Connector

---

---

## Headers

Header	Name	Description
AUDIO1	Front panel audio Headers	9-pin block
CDIN1	CD Audio-In Header	4-pin Block
SPDIF_OUT1	HDMI_SPDIF out header	2-pin Block
USB2/USB3	USB Headers	9-pin Block
SPEAK1	Speaker Header	4-pin Block
PWRLED1	Power LED	3-pin Block
JW_FP1 (PWR LED/ HD LED/ /Power Button /Reset)	Front Panel Header (PWR LED/ HD LED/ Button /Reset)	9-pin Block
CPUFAN1,SFAN1/2	FAN Speed Headers	3-pin Block
IDE1	IDE Hard Disk Drive header	44-pin block
PARALLEL1	Parallel Port Header	25-pin Block
COM2	Serial Port Header	9-pin Block
TX-RXCOM2	RS 232/422/485 port headers	4-pin block
LVDS1	LVDS Header	32-pin Block
INVERTER1	LVDS Inverter Connector	7-pin Block
CN1; CN2	Jetway Daughter Card Connector	50-pin *2 Block
GPIO1	GPIO Header	10-pin Block
LPC1	LPC Header	11-pin Block

---

---

# Chapter 2

## Hardware Installation

### 2-1 Jumper Setting

#### (1) JP1(3-pin): Inverter1 5V/12V Select

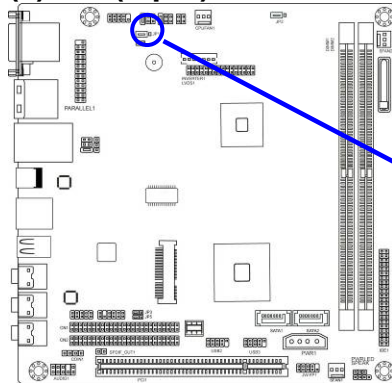

JP1  1-2 closed  
Inverter 12V selected

JP1  2-3 closed  
Inverter 5V select

#### (2) JP2 (3-pin): LVDS1 PVCC 5V / 3.3V Function setting

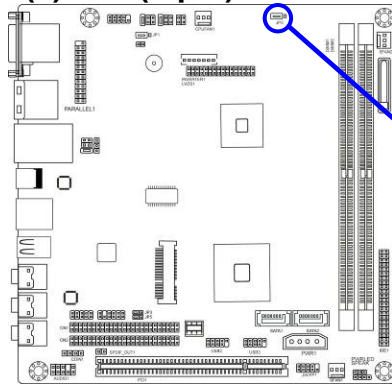

JP2  1 3

1-2 closed: LVDS1 PVCC 5V

JP2  1 3

2-3 closed : LVDS1 PVCC 3.3V

### (3) JP3 (3-pin) : Mini PCI-E Power VCC3.3V/ Dual 3.3 V Function Select

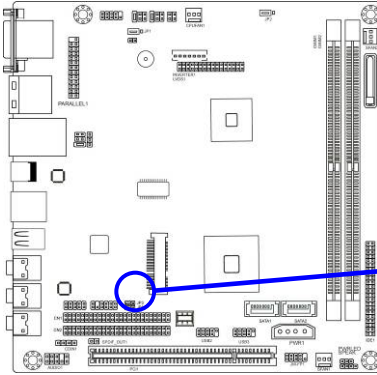

JP3

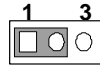

1-2 closed : MINI PCI-E  
VCC= Dual 3.3V

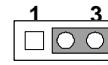

2-3 closed : MINI PCI-E  
VCC= 3.3V

### (4) JP4 (3-pin):K/B, USB Power On Function Setting

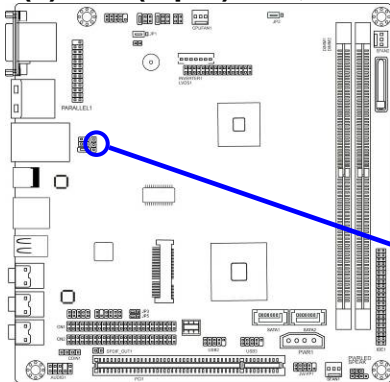

JP4



1-2 Closed:  
KB/MS/USB POWER-ON Disabled (default)

JP4



2-3 closed:  
KB/MS/USB POWER-ON Enabled

### (5) JP5(3-pin): USB2/3 Power On Function Setting

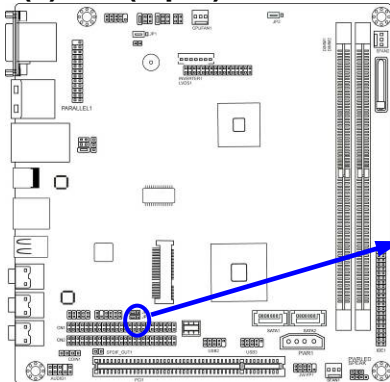

JP5



1-2 closed : USB 2/3 Header POWER-ON Disabled(default)

JP5

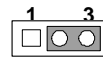

2-3 closed: USB 2/3Header POWER-ON Enabled

---

---

### (6) JCOMP1(6-pin): COM1 Pin9 function select

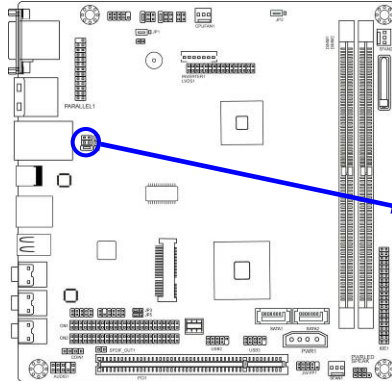

JCOM1P1



1

1-2 closed : RS232



1

3-4 closed : +12V



1

5-6 closed : +5V

### (7) JCOMP2(6-pin): COM2 Pin9 function select

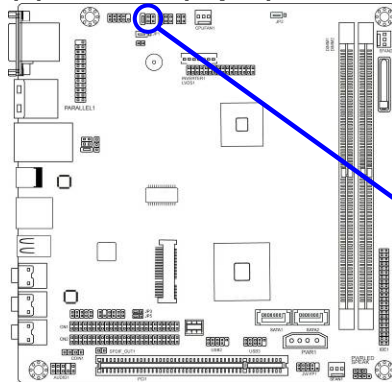

JCOMP2



1

1-2 closed : RS232



1

3-4 closed : +12V



1

5-6 closed : +5V

## (8) JCOM2(6-pin): COM2 Port RS232/485/422 Function Select

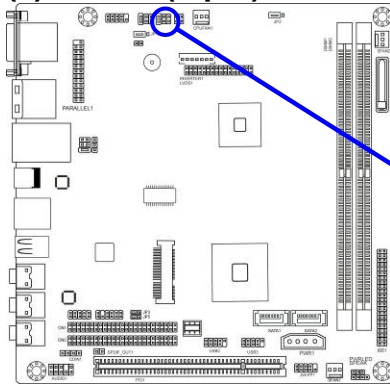

JP8

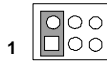

1-2 closed: RS232

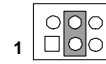

3-4 closed : RS485

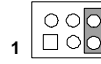

5-6 closed : RS422

## (9) Clear CMOS (2-pin): JBAT

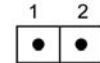
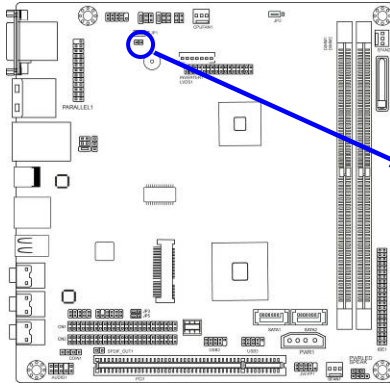

Pin 1-2:open



Pin 1-2:short

JBAT

1-2 Open: Normal

1-2 Short: Clear CMOS

CMOS Clear Setting

---

---

## 2-2 Connectors and Headers

### 2-2-1 Connectors

(1) I/O Panel Connector:

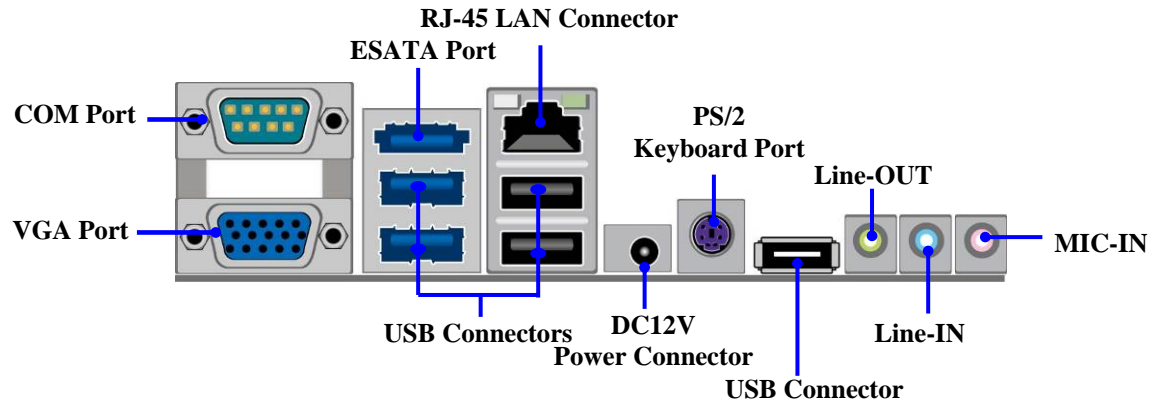

(2) Serial-ATA Port connector: SATA1/SATA2;

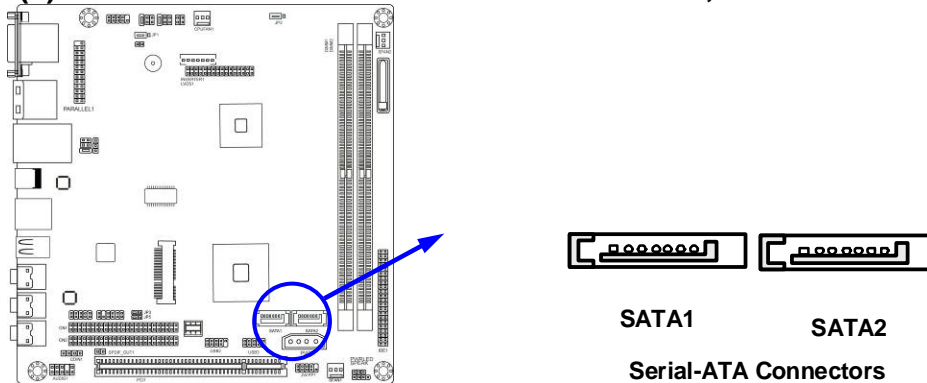

---

---

## 2-2-2 Headers

### (1) Line-Out, MIC-In Header (9-pin): Front Panel Audio Header: AUDIO1

This header connects to Front Panel Line-out, MIC-In connector with cable.

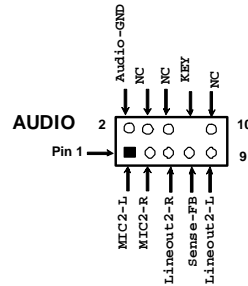
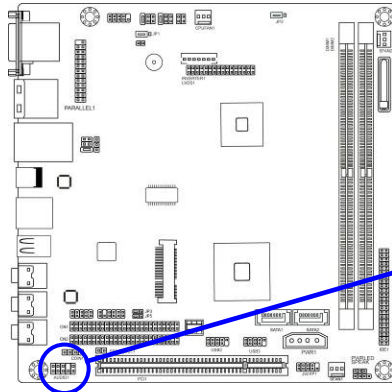

Line-Out, MIC Headers

### (2) CD AUDIO-In Headers (4-pin): CDIN1

CDIN are the connectors for CD-Audio Input signal. Please connect it to CD-ROM CD-Audio output connector.

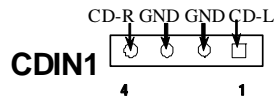
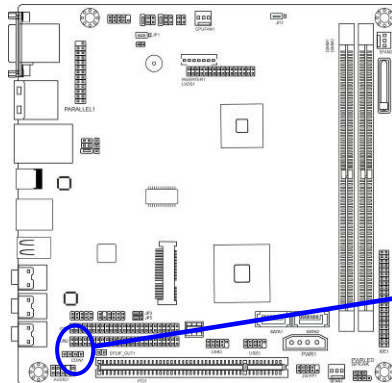

CD Audio-In Headers

---

---

**(3) HDMI-SPDIF Out header: SPDIF\_OUT**

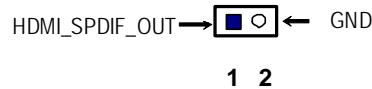
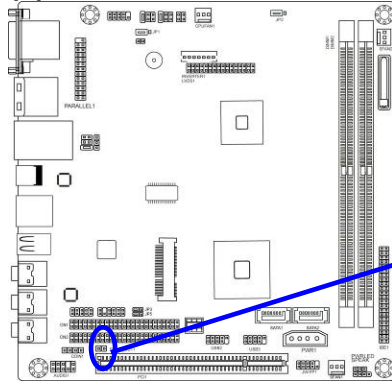

**HDMI\_SPDIF Header**

**(4) USB Port Headers (9-pin): USB2/USB3**

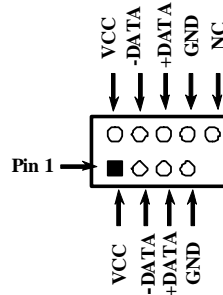
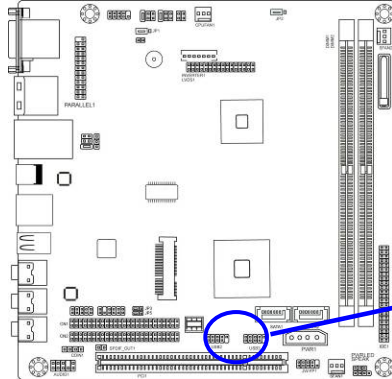

**USB2/3 Header**

**(5) Speaker connector: SPEAK1**

This 4-pin connector connects to the case-mounted speaker. See the figure below.

**(6) Power LED: PWRLED1**

The Power LED is light on while the system power is on. Connect the Power LED from the system case to this pin.

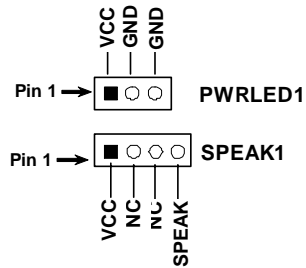
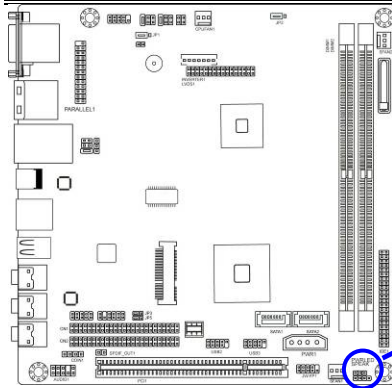

**(7) Front Panel Header: JW-FP1**

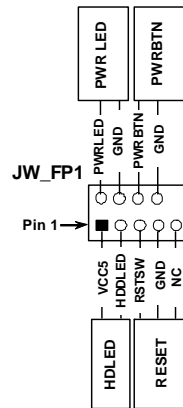
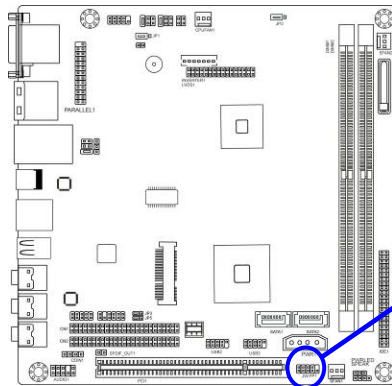

**System Case Connections**

**(8) FAN Speed Headers (3-pin): CPUFAN1, SFAN1/SFAN2**

Pin1: GND

Pin2: +12V fan power

Pin3: Fan Speed

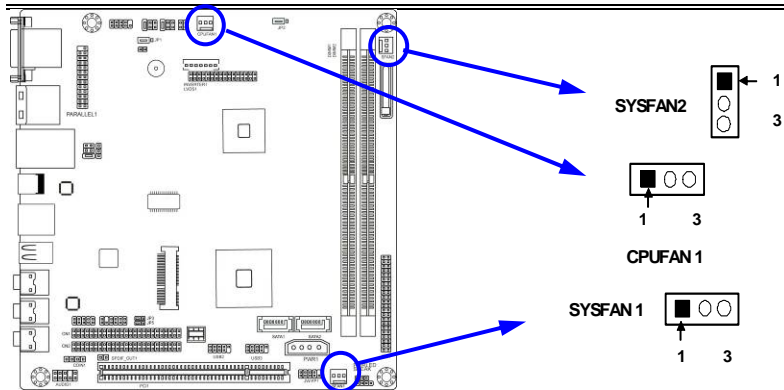

**(9) Serial Port Connectors (9-Pin female): COM2**

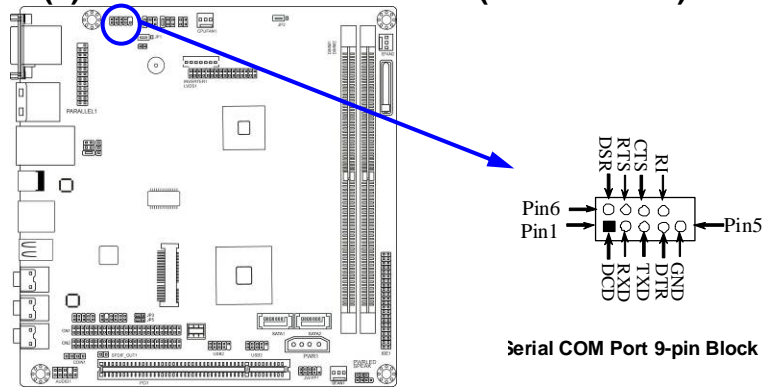

**(10) RS232/422/485 Header: TX-RXCOM2**

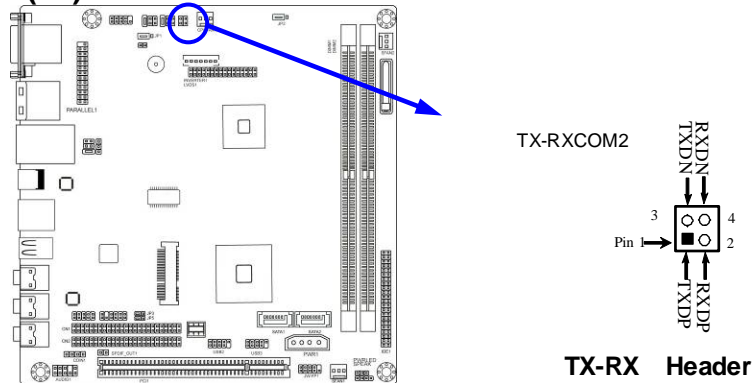

---

---

**(11) LVDS Headers (32 Pin) : LVDS1**

Pin NO.	Pin Define	Pin NO.	Pin Define
Pin 1	NC	Pin 2	NC
Pin 3	NC	Pin 4	NC
Pin 5	NC	Pin 6	NC
Pin 7	NC	Pin 8	NC
Pin 9	NC	Pin 10	NC
Pin 11	LVDS_DDC_DATA	Pin 12	LVDS_DDC_CLK
Pin 13	GND	Pin 14	GND
Pin 15	GND	Pin 16	GND
Pin 17	NC	Pin 18	NC
Pin 19	LVDS_CLKAP	Pin 20	LVDS_CLKAN
Pin 21	LVDSA_DATAP2	Pin 22	LVDSA_DATAN2
Pin 23	LVDSA_DATAP1	Pin 24	LVDSA_DATAN1
Pin 25	LVDSA_DATAP0	Pin 26	LVDSA_DATAN0
Pin 27	PVDD	Pin 28	PVDD
Pin 29	PVDD	Pin 30	PVDD
Pin 31	GND	Pin 32	GND

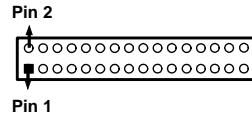
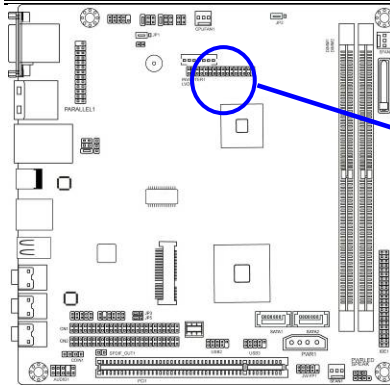

LVDS1

### (12) LVDS Inverter headers: Inverter1

Pin 1 and pin2: VCC of inverter

Pin3, pin4 and pin6: GND

Pin5: Backlight

Pin7: Brightness

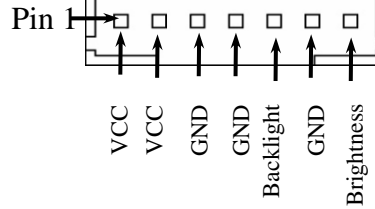
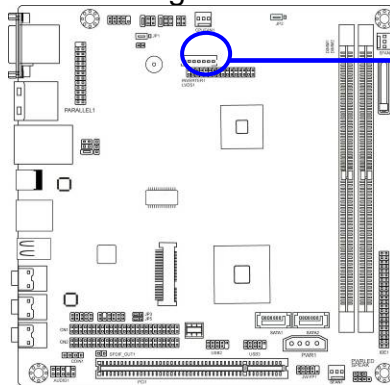

### (13) GPIO Header (10-pin): GPIO1

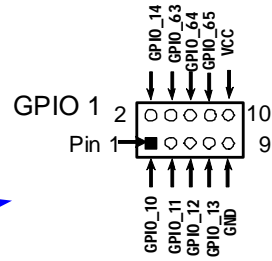
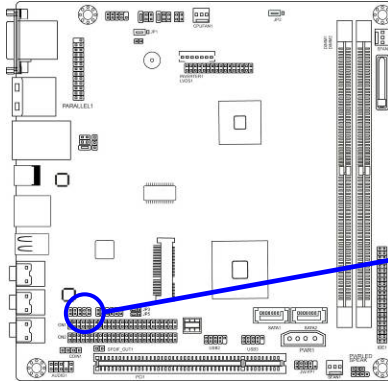

GPIO1 Header

### (14) LPC Connector (12-pin): LPC1

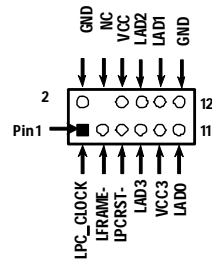
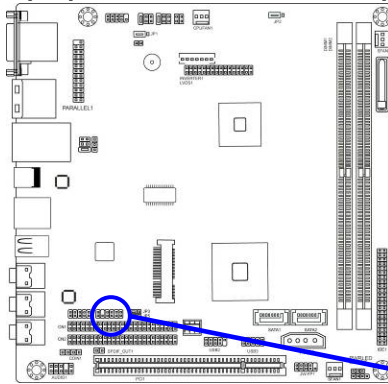

LPC1 Connector

---

---

## Chapter 3

### Introducing BIOS

**Notice!** The BIOS options in this manual are for reference only. Different configurations may lead to difference in BIOS screen and BIOS screens in manuals are usually the first BIOS version when the board is released and may be different from your purchased motherboard. Users are welcome to download the latest BIOS version form our official website.

The BIOS is a program located on a Flash Memory on the motherboard. This program is a bridge between motherboard and operating system. When you start the computer, the BIOS program will gain control. The BIOS first operates an auto-diagnostic test called POST (power on self test) for all the necessary hardware, it detects the entire hardware device and configures the parameters of the hardware synchronization. Only when these tasks are completed done it gives up control of the computer to operating system (OS). Since the BIOS is the only channel for hardware and software to communicate, it is the key factor for system stability, and in ensuring that your system performance as its best.

In the BIOS Setup main menu of Figure 3-1, you can see several options. We will explain these options step by step in the following pages of this chapter, but let us first see a short description of the function keys you may use here:

- Press <Esc> to quit the BIOS Setup.
- Press ↑↓←→ (up, down, left, right) to choose, in the main menu, the option you want to confirm or to modify.
- Press <F10> when you have completed the setup of BIOS parameters to save these parameters and to exit the BIOS Setup menu.
- Press Page Up/Page Down or +/- keys when you want to modify the BIOS parameters for the active option.

---

---

## **3-1 Entering Setup**

Power on the computer and by pressing <Del> immediately allows you to enter Setup. If the message disappears before your respond and you still wish to enter Setup, restart the system to try again by turning it OFF then ON or pressing the “RESET” button on the system case. You may also restart by simultaneously pressing <Ctrl>, <Alt> and <Delete> keys. If you do not press the keys at the correct time and the system does not boot, an error message will be displayed and you will again be asked to

**Press <Del> to enter Setup**

## **3-2 Getting Help**

### **Main Menu**

The on-line description of the highlighted setup function is displayed at the bottom of the screen.

### **Status Page Setup Menu/Option Page Setup Menu**

Press F1 to pop up a small help window that describes the appropriate keys to use and the possible selections for the highlighted item. To exit the Help Window, press <Esc>.

## **3-3 The Main Menu**

Once you enter AMI ® BIOS CMOS Setup Utility, the Main Menu (Figure 3-1) will appear on the screen. The Main Menu allows you to select from fourteen setup functions and two exit choices. Use arrow keys to select among the items and press <Enter> to accept or enter the sub-menu.

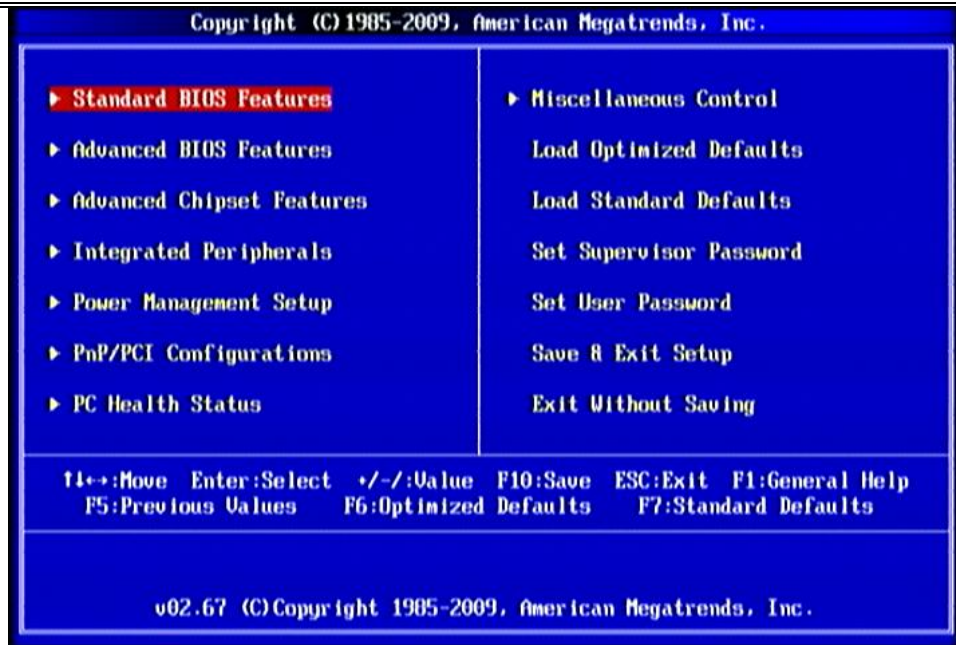

Figure 3-1

### **Standard BIOS Features**

Use this Menu for basic system configurations.

### **Advanced BIOS Features**

Use this menu to set the Advanced Features available on your system.

### **Advanced Chipset Features**

Use this menu to change the values in the chipset registers and optimize your system's performance.

### **Integrated Peripherals**

Use this menu to specify your settings for integrated peripherals.

### **Power Management Setup**

Use this menu to specify your settings for power management.

### **PnP/PCI Configurations**

Use this menu to specify your settings for PnP and PCI configurations.

### **PC Health Status**

This entry shows your PC health status.

---

---

### **Miscellaneous Control**

Use this menu to specify your settings for Miscellaneous Control.

### **Load Optimized Defaults**

Use this menu to load the BIOS default values these are setting for optimal performances system operations for performance use.

### **Load Standard Defaults**

Use this menu to load the BIOS default values for the minimal/stable performance system operation

### **Set Supervisor Password**

Use this menu to set supervisor password.

### **Set User Password**

Use this menu to set user password.

### **Save & Exit Setup**

Save CMOS value changes to CMOS and exit setup.

### **Exit Without Saving**

Abandon all CMOS value changes and exit setup.

## **3-4 Standard BIOS Features**

The items in Standard CMOS Setup Menu are divided into several categories. Each category includes no, one or more than one setup items. Use the arrow keys to highlight the item and then use the <PgUp> or <PgDn> keys to select the value you want in each item.

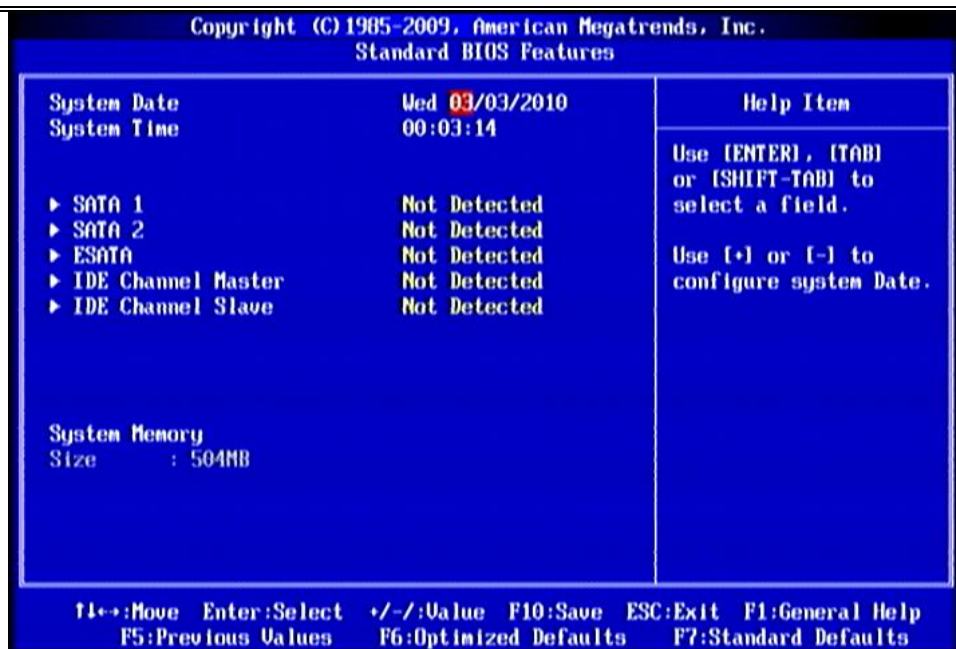

### System Date

The date format is <day><month><date><year>.

**Day** Day of the week is from Sun to Sat, determined by BIOS. Read-only.

**Month** The month is from Jan. through Dec.

**Date** The date from 1 to 31 can be keyed by numeric function keys.

**Year** The year depends on the year of the BIOS.

### System Time

The time format is <hour><minute><second>.

### SATA 1/SATA 2/ESATA

### IDE Channel Master/Slave

While entering setup, BIOS auto detects the presence of harddisk devices. This displays the status of auto detection of harddisk devices.

**Type:** The optional settings are: Not Installed; Auto; CD/DVD and ARMD.

**LBA/Large Mode:** The optional settings are Auto; Disabled.

Disabled: disables LBA mode.

---

---

Auto: enables LBA Mode if the devices support it and the device is not already formatted with LBA Mode disabled.

**Block (Multi-Sector Transfer):** The optional settings are: Disabled and Auto.

Disabled: The Data transfer from and to the device occurs one sector at a time.

Auto: The Data transfer from and to the device occurs multiple sectors at a time if the device supports it.

**PIO Mode: the optional settings are:** Auto, 0, 1, 2, 3 and 4.

**DMA MODE:** the optional settings are Auto, SWDMAn, MWDMAAn , UDMAAn.

**S.M.A.R.T.:** This option allows you to enable the HDD S.M.A.R.T Capability (Self-Monitoring, Analysis and Reporting Technology). The optional settings are Auto; Disabled; and Enabled.

**32 Bit Data Transfer:** the optional settings are: Disabled and Enabled.

### 3-5 Advanced BIOS Features



---

---

### **Virus Warning**

The selection Allow you to choose the VIRUS Warning feature for IDE Hard Disk boot sector protection. If this function is enabled and someone attempt to write data into this area, BIOS will show a warning message on screen and alarm beep.

**Disabled** (default) No warning message to appear when anything attempts to access the boot sector or hard disk partition table.

**Enabled** Activates automatically when the system boots up causing a warning message to appear when anything attempts to access the boot sector of hard disk partition table.

### **Quick Power On Self Test**

This item allows BIOS to skip certain tests while booting. This will decrease the time needed to boot the system. The optional settings: Disabled; Enabled.

### **Boot Up NumLock Status**

The default value is On.

**On** (default) Keypad is numeric keys.

**Off** Keypad is arrow keys.

### **APIC Mode**

Use this item to include ACPI APIC table pointer to ESDT pointer list. The optional settings are: Disabled; Enabled.

### **MPS Version Control for OS**

This option is only valid for multiprocessor motherboards as it specifies the version of The Multiprocessor Specification (MPS) that the motherboard will use.

### **Quiet Boot**

The optional settings: Disabled; Enabled.

Disabled: Displays normal POST messages. Enabled: Displays OEM logo instead of POST messages.

---

## 3-5-1 CPU Feature

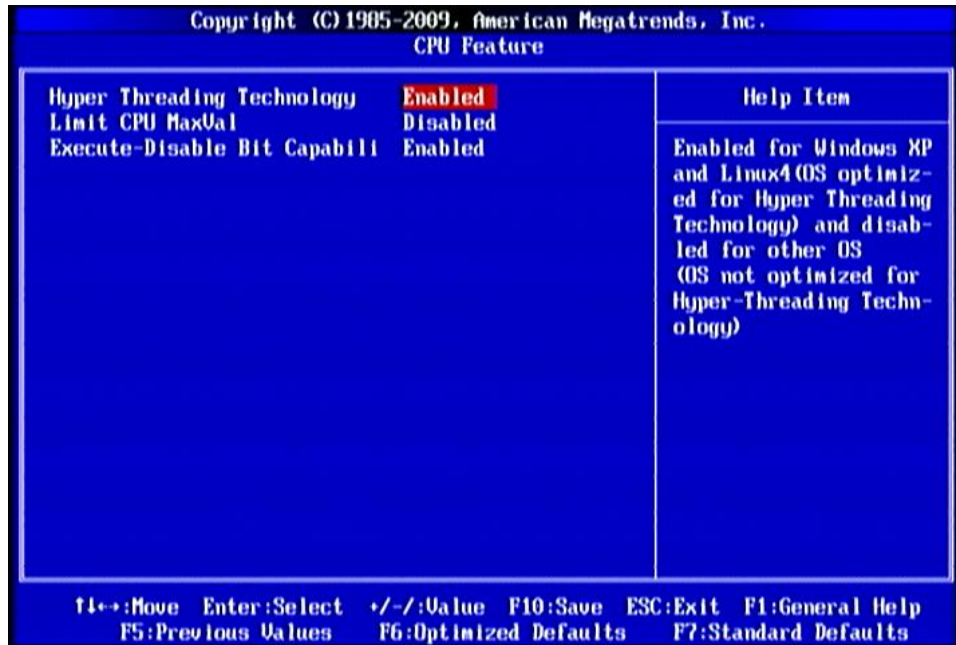

### Hyper Threading Technology

Enabled for Windows XP and Linux4(OS optimized for Hyper Threading Technology) and disabled for other OS (OS not optimized for Hyper –Threading Technology)

### Limit CPU MaxUal

The optional settings are: Disabled; Enabled.

### Execute-Disable Bit Capabil1

The optional settings are: Disabled; Enabled. When disabled, force the XD feature Flag to always return 0.

---

---

## 3-6 Advanced Chipset Features

The Advanced Chipset Features Setup option is used to change the values of the chipset registers. These registers control most of the system options in the computer.

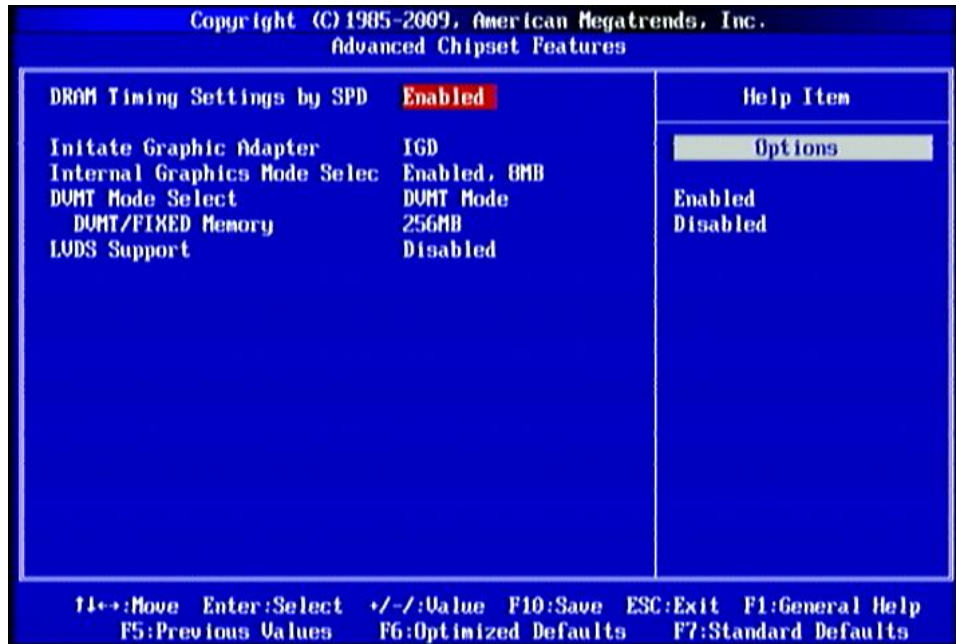

### DRAM Timing Settings by SPD

The optional settings are: Disabled; Enabled.

### Initate Graphic Adapter

The optional settings are: 1GD; PCIE/IGD. Select which graphic controller to use as the primary boot device.

### Internal Graphics Mode Select

Use this item to select the amount of system memory used by the internal graphics device. The optional settings: Disabled; Enabled, 4MB. Enabled, 8MB.

### DVMT Mode Select

The optional value is: Fixed Mode; DVMT Mode.

### DVMT/FIXED Memory

---

---

The optional values are: 128MB; 256 MB; Maximum DVMT.

### LVDS Support

The optional settings are: Disabled; Enabled.

## 3-7 Integrated Peripherals

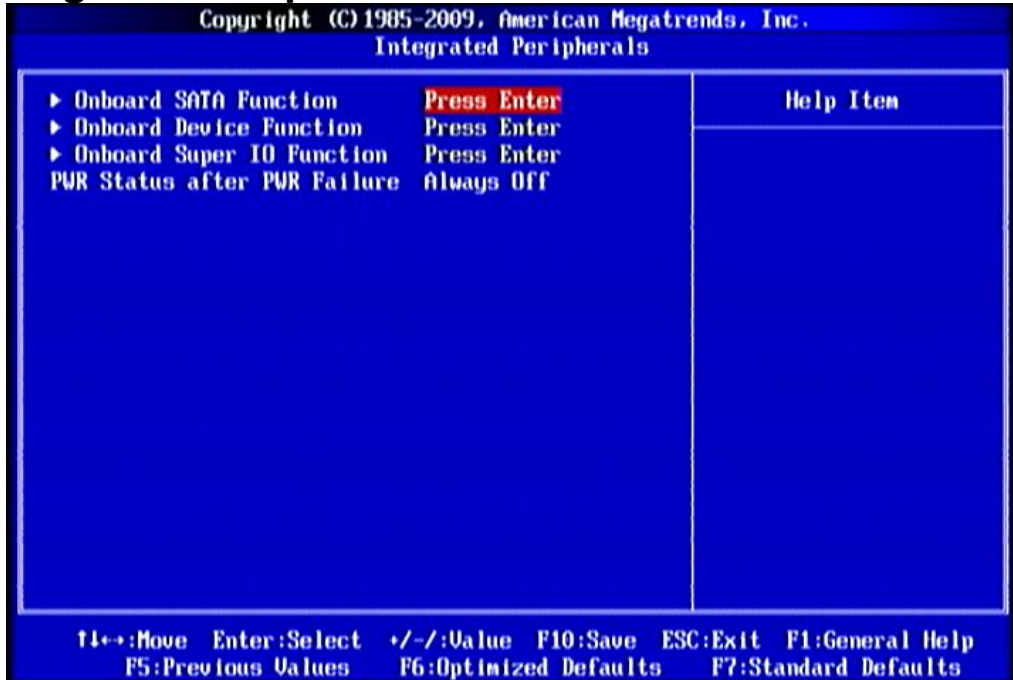

### PWR Status after PWR Failure

The optional settings are: Always off; Always on; Former Status.

---

## 3-7-1 Onboard SATA Function

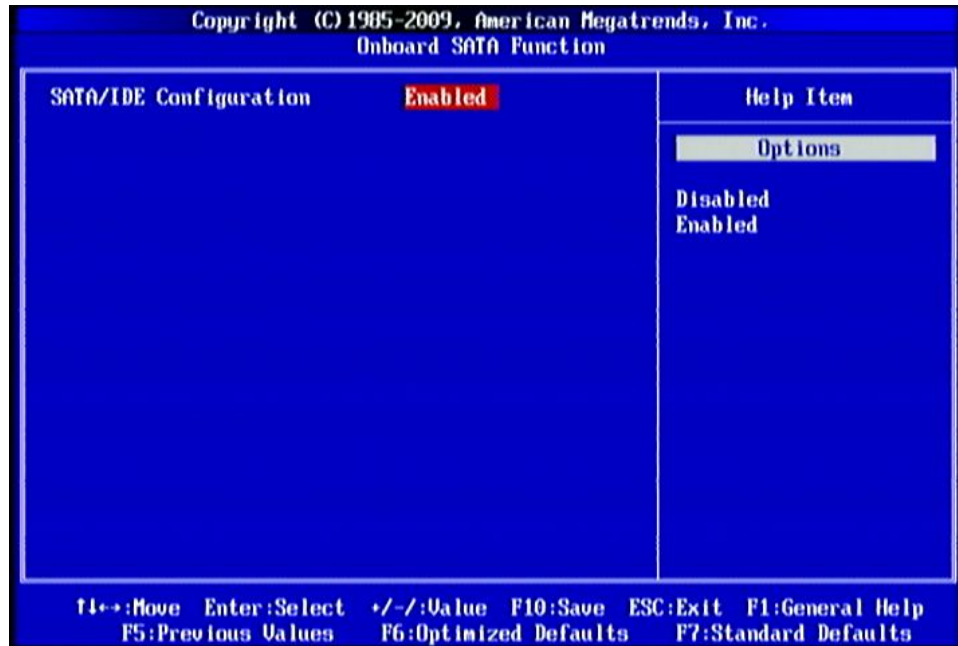

---

---

## 3-7-2 Onboard Device Function



### High Definition Audio

This item allows you to decide to auto /disable the chipset family to support HD Audio. The settings are: Auto, Disabled.

### Onboard LAN Controller

The optional settings are: Enabled; Disabled.

### Onboard LAN Boot ROM

The optional settings are: Enabled; Disabled.

### Mini PCIE Device

The optional settings are: Enabled; Disabled.

### Mini PCIE Wireless Single

The optional settings are: Enabled; Disabled.

### USB 2.0 Operation Mode

The settings are: FullSpeed; HiSpeed.

---

---

## USB Host Controller/USB 2.0 Function / Keyboard Legacy/Mouse Legacy /Storage Legacy Support

Select enabled if your system contains a Universal Serial Bus (USB) controller and you have a USB mouse /keyboard/USB storage device. The settings are: Enabled, Disabled.

### 3-7-3 Onboard Super IO Function

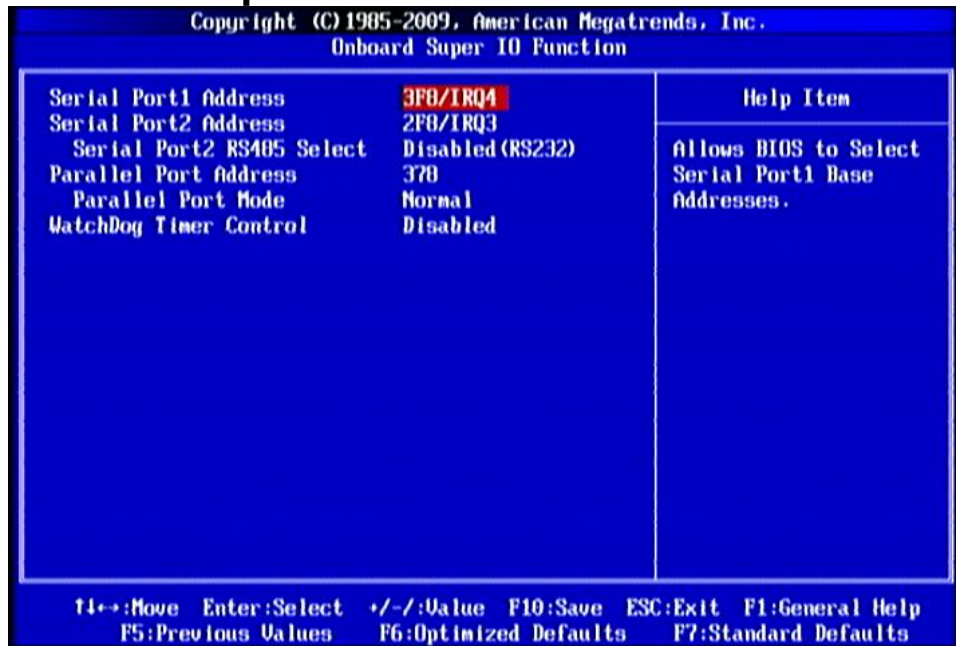

#### Serial Port 1 Address

The optional settings are: Disabled, 3F8/IRQ4, 3E8/IRQ4, 2E8/IRQ3.

#### Serial Port 2 Address

The optional settings are: Disabled, 2F8/IRQ3, 3E8/IRQ4, 2E8/IRQ3.

#### Serial Port 2 RS485 Select

The optional settings are: Disabled(RS232); Enabled(RS485)

#### Parallel Port Address

Use this item to allow BIOS to select parallel port base addresses

---

---

The optional settings are: Disabled; 378; 278; 3BC

### Parallel Port Mode

The optional settings are: Normal; Bi-Directional; ECP; EPP; ECP & EPP.

### Watchdog Timer Select

This item is used to activate the watchdog function. The optional settings are: Enabled; Disabled.

When set as Enabled, The following subitems shall appear:

WatchDog Timer Val: User can typing a numbering the range of 10 to 255.

WatchDog Timer Unit: The optional settings are: Sec.; Min. .

## 3-8 Power Management Setup

The Power Management Setup allows you to configure your system to most effectively save energy saving while operating in a manner consistent with your own style of computer use.

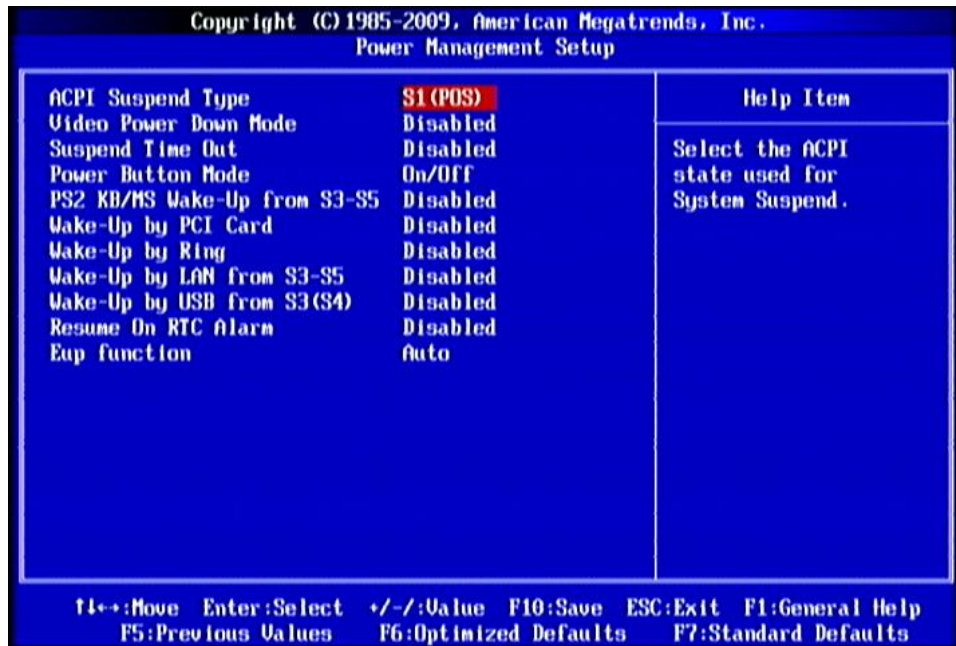

---

---

### ACPI Suspend Type

Users can select the ACPI state used for system suspend. The optional settings are: S1(POS); S3(STR).

### Video Power Down Mode

The optional settings: Disabled; Standby; Suspend.

### Suspend Time out

Use this item to select the specified time for system to go into suspend. The optional settings are: Disabled;1 Min,2 Min;4 Min;8 Min;10 Min;20 Min;30 Min;40 Min;50 Min;60 Min.

### Power Button Mode

Use this item to go into On/Off or Suspend when power button is pressed.

**PS2 KB/MS Wake-Up from S3-S5; Wake-Up by PCI Card; Wake-Up by Ring;Wake-Up by LAN from S3-S5;Wake-Up by USB from S3(S4);Resume by Alarm.**

User can set them as Enabled or Disable for to enable or disble respective functions.

### ERP (EUP) Function

The optional settings are: Auto; Disabled.

## 3-9 PnP/PCI Configurations



### IRQ Resources

Names the interrupt request (IRQ) line assigned to the USB on your system. Activity of the selected IRQ always awakens the system.

### PCI/VGA Palette Snoop

This item is designed to overcome problems that can be caused by some non-standard VGA cards. This board includes a built-in VGA system that does not require palette snooping so you must leave this item disabled.

---

## 3-10 PC Health Status

This section shows the Status of you CPU, Fan, and Warning for overall system status. This is only available if there is Hardware Monitor onboard.

Copyright (C) 1985-2009, American Megatrends, Inc.  
PC Health Status

Shutdown Temperature	Disabled	Help Item Options Disabled 60°C/140°F 65°C/149°F 70°C/158°F 75°C/167°F
CPU Thermal-Throttling	Disabled	
▶ Smart FAN Configurations	Press Enter	
+5V OUT	10%	
+12V OUT	10%	
Vcc3V OUT	20%	
CPU Temperature	45°C/113°F	
System Temperature	41°C/105°F	
CPUFAN Speed	N/A	
SYSFAN1 Speed	N/A	
SYSFAN2 Speed	N/A	
Vcore	1.168 V	
NB 1.05V	1.048 V	
5VSB	5.061 V	
VDIMM	1.787 V	
+ 5V	5.061 V	
+ 12V	11.968 V	

F1←→:Move Enter:Select +/-:Value F10:Save ESC:Exit F1:General Help  
F5:Previous Values F6:Optimized Defaults F7:Standard Defaults

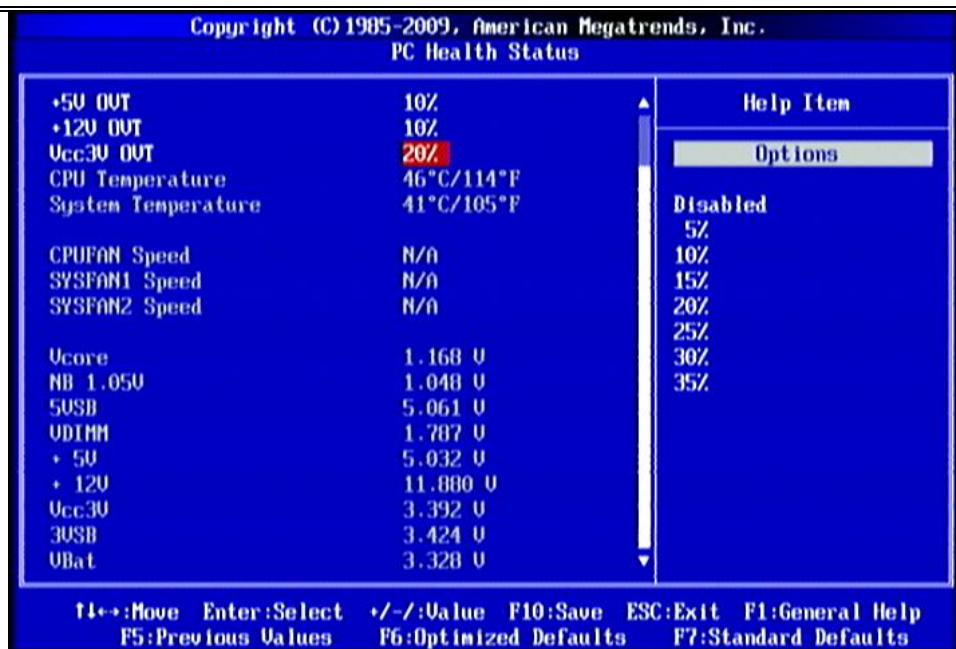

### Shutdown Temperature

This item can let users setting the Shutdown temperature, when CPU temperature over this setting the system will auto shutdown to protect CPU.

### CPU Thermal Throttling

The optional settings are: Disabled; Enabled. When it is set as Enabled user could set value for CPU Thermal-Throttling Temp.; CPU Thermal-Throttling Duty and CPU Thermal-Throttling Beep.

### Smart Fan Configuration

Press Enter to set certain values for the following three items: CPUFAN Smart Mode , SYSFAN1 Smart Mode and SYSFAN2 Smart Mode to set respectively for value in Full-Speed Temp.; Idle Temp. and Idle-Speed Duty .

### +5V OUT/+12V OUT/Vcc3V OUT

Use this item to select a value for +5V OUT/+12V OUT/Vcc3V OUT from the optional setting range..

---

**CPU Temperature/ System Temperature/ /CPUFAN/ SYSFAN1/SYSFAN2 Speed/  
Vcore/ /NB1.05V/5VSB/VDIMM/ +5V/+12V/5 /Vcc3V/3VSB/VBat /**

This will show the CPU/FAN/System voltage chart and FAN Speed, etc.

### 3-11 Miscellaneous Control

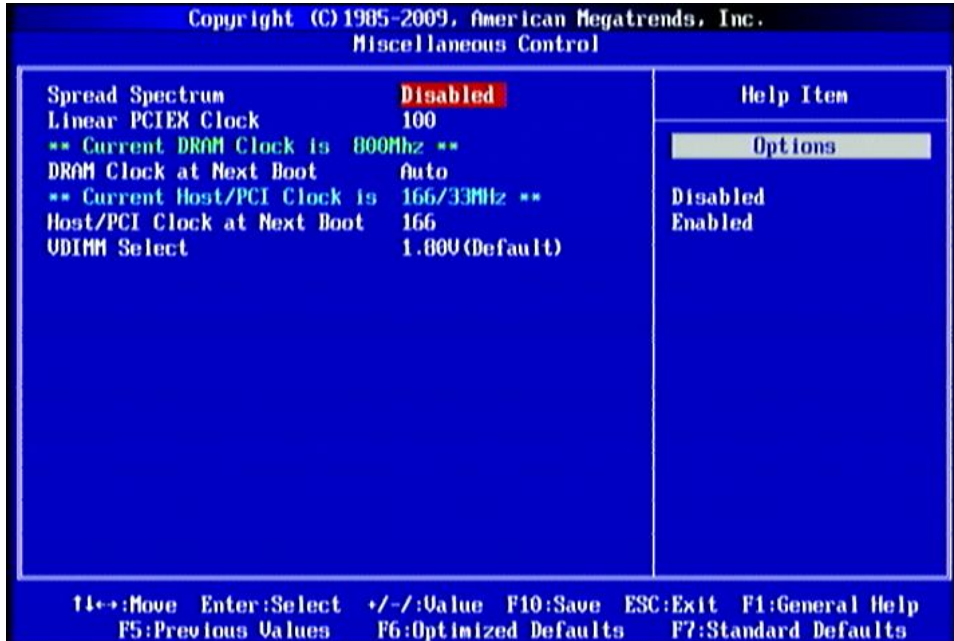

#### Spread Spectrum

The optional settings are: Enabled; Disabled.

#### Linear PCIEX Clock

The optional settings are from 100 to 200.

#### DRAM Clock at Next Boot

This item allows you to set DRAM clock. The optional settings are: Auto; 667MHz; 800MHz

#### Host/PCI Clock at Next Boot

The optional settings are from 166 to 600.

#### VDIMM Select

---

---

Use this item to select a voltage value for DIMM. The optional value is from 1.80V(Default) to 1.95V.

### **3-12 Password Setting**

You can set either supervisor or user password, or both of them. The differences are:

**Supervisor password:** Can enter and change the options of the setup menus.

**User password:** Can only enter but do not have the right to change the options of the setup menus. When you select this function, the following message will appear at the center of the screen to assist you in creating a password.

#### **ENTER PASSWORD:**

Type the password, up to eight characters in length, and press <Enter>. The password typed now will clear any previously entered password from CMOS memory. You will be asked to confirm the password. Type the password again and press <Enter>. You may also press <Esc> to abort the selection and not enter a password. To disable a password, just press <Enter> when you are prompted to enter the password. A message will confirm that the password will be disabled. Once the password is disabled, the system will boot and you can enter Setup freely.

#### **PASSWORD DISABLED.**

When a password has been enabled, you will be prompted to enter it every time you try to enter Setup. This prevents an unauthorized person from changing any part of your system configuration.

Additionally, when a password is enabled, you can also require the BIOS to request a password every time your system is rebooted. This would prevent unauthorized use of your computer.

You determine when the password is required within the BIOS Features Setup Menu and its Security option. If the Security option is set to "System", the password will be required both at boot and at entry to Setup. If set to "Setup", prompting only occurs when trying to enter Setup.

---

---

## 3-13 Load Optimized /Standard Defaults

### Load Optimized Defaults

When you press <Enter> on this item, you get a confirmation dialog box with a message similar to:



Pressing <OK> loads the default values that are factory settings for optimal performance system operations.

### Load Standard Defaults

When you press <Enter> on this item, you get a confirmation dialog box with a message similar to:



Pressing <OK> loads the default values that are factory settings for stable performance system operations.

## 3-14 Save & Exit Setup/ Exit Without Saving

### Save and Exit Setup

When you press <Enter> on this item, you get a confirmation dialog box with a message similar to:



Pressing <OK> save the values you made previously and exit BIOS setup.

---

---

## Exit Without Saving

When you press <Enter> on this item, you get a confirmation dialog box with a message similar to:

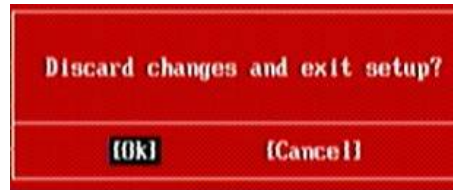

Pressing <OK> to leave BIOS setting without saving previously set values.