



IMB-1220

IMB-1221

IMB-X1220

User Manual

Version 1.0

Published May 2020

Copyright©2020 ASRockInd INC. All rights reserved.

Version 1.0

Published May 2020

Copyright©2020 ASRockInd INC. All rights reserved.

Copyright Notice:

No part of this documentation may be reproduced, transcribed, transmitted, or translated in any language, in any form or by any means, except duplication of documentation by the purchaser for backup purpose, without written consent of ASRockInd Inc.

Products and corporate names appearing in this documentation may or may not be registered trademarks or copyrights of their respective companies, and are used only for identification or explanation and to the owners' benefit, without intent to infringe.

Disclaimer:

Specifications and information contained in this documentation are furnished for informational use only and subject to change without notice, and should not be constructed as a commitment by ASRockInd. ASRockInd assumes no responsibility for any errors or omissions that may appear in this documentation.

With respect to the contents of this documentation, ASRockInd does not provide warranty of any kind, either expressed or implied, including but not limited to the implied warranties or conditions of merchantability or fitness for a particular purpose.

In no event shall ASRockInd, its directors, officers, employees, or agents be liable for any indirect, special, incidental, or consequential damages (including damages for loss of profits, loss of business, loss of data, interruption of business and the like), even if ASRockInd has been advised of the possibility of such damages arising from any defect or error in the documentation or product.



This device complies with Part 15 of the FCC Rules. Operation is subject to the following two conditions:

- (1) this device may not cause harmful interference, and
- (2) this device must accept any interference received, including interference that may cause undesired operation.

CALIFORNIA, USA ONLY

The Lithium battery adopted on this motherboard contains Perchlorate, a toxic substance controlled in Perchlorate Best Management Practices (BMP) regulations passed by the California Legislature. When you discard the Lithium battery in California, USA, please follow the related regulations in advance.

“Perchlorate Material-special handling may apply, see www.dtsc.ca.gov/hazardouswaste/perchlorate”

ASRockInd Website: <http://www.asrockind.com>

The terms HDMI® and HDMI High-Definition Multimedia Interface, and the HDMI logo are trademarks or registered trademarks of HDMI Licensing LLC in the United States and other countries.



CAUTION:

RISK OF EXPLOSION IF BATTERY IS REPLACED BY AN INCORRECT TYPE.
DISPOSE OF USED BATTERIES ACCORDING TO THE INSTRUCTIONS.

Contents

1 Introduction	5
1.1 Package Contents	5
1.2 Specifications.....	6
1.3 Motherboard Layout.....	9
1.4 I/O Panel.....	11
2 Installation	13
2.1 Screw Holes.....	13
2.2 Pre-installation Precautions	13
2.3 Installation of Memory Modules (SO-DIMM).....	14
2.4 Expansion Slots	16
2.5 Jumpers Setup.....	17
2.6 Onboard Headers and Connectors.....	20
2.7 Installation of ROM Socket	25
3 UEFI SETUP UTILITY.....	26
3.1 Introduction	26
3.1.1 UEFI Menu Bar	26
3.1.2 Navigation Keys	27
3.2 Main Screen.....	27
3.3 Advanced Screen.....	28
3.3.1 CPU Configuration	29
3.3.2 Chipset Configuration.....	31
3.3.3 Storage Configuration	33
3.3.4 Super IO Configuration	34
3.3.5 AMT Configuration	35
3.3.6 ACPI Configuration.....	37
3.3.7 USB Configuration	38
3.3.8 Trusted Computing.....	39
3.4 Hardware Health Event Monitoring Screen	40
3.5 Security Screen	41
3.6 Boot Screen	42
3.7 Exit Screen	44
4 Software Support	45
4.1 Install Operating System.....	45
4.2 Support CD Information	45
4.2.1 Running Support CD.....	45
4.2.2 Drivers Menu.....	45
4.2.3 Utilities Menu.....	45
4.2.4 Contact Information.....	45

Chapter 1: Introduction

Thank you for purchasing ASRockInd **IMB-1220 / IMB-1221 / IMB-X1220** motherboard, a reliable motherboard produced under ASRockInd's consistently stringent quality control. It delivers excellent performance with robust design conforming to ASRockInd's commitment to quality and endurance.

In this manual, chapter 1 and 2 contain introduction of the motherboard and step-by-step guide to the hardware installation. Chapter 3 and 4 contain the configuration guide to BIOS setup and information of the Support CD.



Because the motherboard specifications and the BIOS software might be updated, the content of this manual will be subject to change without notice. In case any modifications of this manual occur, the updated version will be available on ASRockInd website without further notice. You may find the latest VGA cards and CPU support lists on ASRockInd website as well. ASRockInd website <http://www.asrockind.com>

If you require technical support related to this motherboard, please visit our website for specific information about the model you are using.

www.asrockind.com/support/index.asp

1.1 Package Contents

ASRockInd **IMB-1220 / IMB-1221 / IMB-X1220** Motherboard

(Mini-ITX Form Factor: 6.7-in x 6.7-in, 17.0 cm x 17.0 cm)

ASRockInd **IMB-1220 / IMB-1221 / IMB-X1220** Driver CD

ASRockInd **IMB-1220 / IMB-1221 / IMB-X1220** Jumper setting instruction

1 x I/O Panel Shield

1.2 Specifications

Form Factor	Dimensions	Mini-ITX (6.7-in x 6.7-in x 1.5-in)
Processor System	CPU	Intel® 10 th Gen (Cometlake-S) Core™ Processors, up to 80W * The performance of CPUs over 80W will be limited due to power design.
	Chipset	IMB-1220: Intel® Q470E IMB-1221: Intel® H420E IMB-X1220: Intel® W480E
	Socket	LGA1200
	BIOS	AMI SPI 256 Mbit
Expansion Slot	PCIe	1 x PCIe x16 (Gen3, Support riser card x8/x8, x8/x4/x4)
	Mini-PCIe	N/A
	PCI	N/A
	M.2	1 x M.2 (Key E, 2230) with PCIe x1, USB 2.0 and CNVio for Wireless 1 x M.2 (Key B, 3042) with PCIe x1/USB3.0/USB2.0 and SIM for 4G/5G
	SIM Socket	1 x SIM socket connected to M.2 key B
Memory	Technology	Dual Channel DDR4 2933/2666/2400 MHz - Intel® Core i9/i7 CPUs support DDR4 up to 2933 MHz - Intel® Core i5/i3 CPUs support DDR4 up to 2666 MHz - Intel® Pentium/Celeron CPU support DDR4 up to 2400 MHz * Only IMB-X1220 supports ECC RAM
	Capacity	64GB (32 GB per DIMM)
	Socket	2 x 260-pin SO-DIMM
Graphics	Controller	Intel® UHD Graphics
	HDMI	HDMI 2.0a Max resolution up to 4096x2160 @60Hz
	DisplayPort	DisplayPort 1.2, DP++ Max resolution up to 4096x2160@60Hz
	VGA	Max resolution up to 1920x1200@60Hz (IMB-1220-L)

	LVDS	Dual channel 24 bit up to 1920x1200@60Hz (IMB-1220-L)
	eDP	eDP 1.4, Max resolution up to 4096x2304@60Hz (IMB-1220-D)
	DVI	N/A
	MultiDisplay	IMB-1220 / IMB-X1220: Triple Display IMB-1221: Dual Display
Ethernet	Controller/ Speed	IMB-1220 / IMB-X1220: LAN1: Intel® I225LM with 10/100/1000/2500 Mbps LAN2: Intel® I219LM, with 10/100/1000 Mbps, support AMT/vPro IMB-1221: LAN1: Intel® I225LM with 10/100/1000/2500 Mbps LAN2: Intel® I219V with 10/100/1000 Mbps
	Connector	2 x RJ-45
Audio	Interface	Realtek ALC887 HD, High Definition Audio. Line-out, Mic-in.
Rear I/O	HDMI	1 x HDMI 2.0a
	DisplayPort	1 x DP 1.2 (IMB-1220-L) 2 x DP 1.2 (IMB-1220-D)
	VGA	1 (IMB-1220-L)
	DVI	N/A
	Ethernet	1 x 1 Gigabit LAN + 1 x 2.5 Gigabit LAN
	USB	IMB-1220 / IMB-X1220: 4 x USB 3.2 (Gen1) IMB-1221: 2 x USB 3.2 (Gen1) + 2 x USB 2.0
	Audio	2 (Mic-in, Line-out)
	COM	2 x COM (RS232/422/485)
	PS2	N/A
Internal Connector	USB	2 x USB 3.2 Gen1 (1 x USB 3.2 Gen1 header) IMB-1220 / IMB-X1220: 4 x USB 2.0 (2 x 2.54 pitch header) IMB-1221: 2 x USB 2.0 (1 x 2.54 pitch header)
	COM	IMB-1220 / IMB-X1220: 3 x COM (RS232) IMB-1221: 2 x COM (RS232)
	Parallel	N/A
	GPIO	4 x GPI, 4 x GPO

	TPM	TPM 2.0 onboard (For IMB-1220 / IMB-X1220 Only)
	LVDS	1 (IMB-1220-L)
	eDP	1 (IMB-1220-D)
	VGA	N/A
	SATA PWR Output	1
	Speaker Header	1
Storage	M.2	1 x M.2 (Key M, 2242/2260/2280) with PCIe4 (IMB-1220 / IMB-X1220) / PCIe2 (IMB-1221) and SATA3 for SSD * For IMB-1221, if M2M_1 is occupied by a SATA-type M.2 device, SATA3_1 will be disabled.
	mSATA	N/A
	SATA	4 x SATA3 (6Gb/s)
	eMMC	N/A
Watchdog Timer	Output	From super I/O to drag RESETCON#
	Interval	256 Segments, 0,1,2...255 Sec
Power Requirements	Input PWR	ATX PWR 4pin+24 Pin
	Power On	AT/ATX Supported AT: Directly PWR on as Power input ready ATX: Press Button to PWR on after Power input ready
Environment	Operating Temp	0°C ~ 60°C
	Storage Temp	-40°C ~ 85°C
	Operating Humidity	5% ~ 90%
	Storage Humidity	5% ~ 90%

1.3 Motherboard Layout

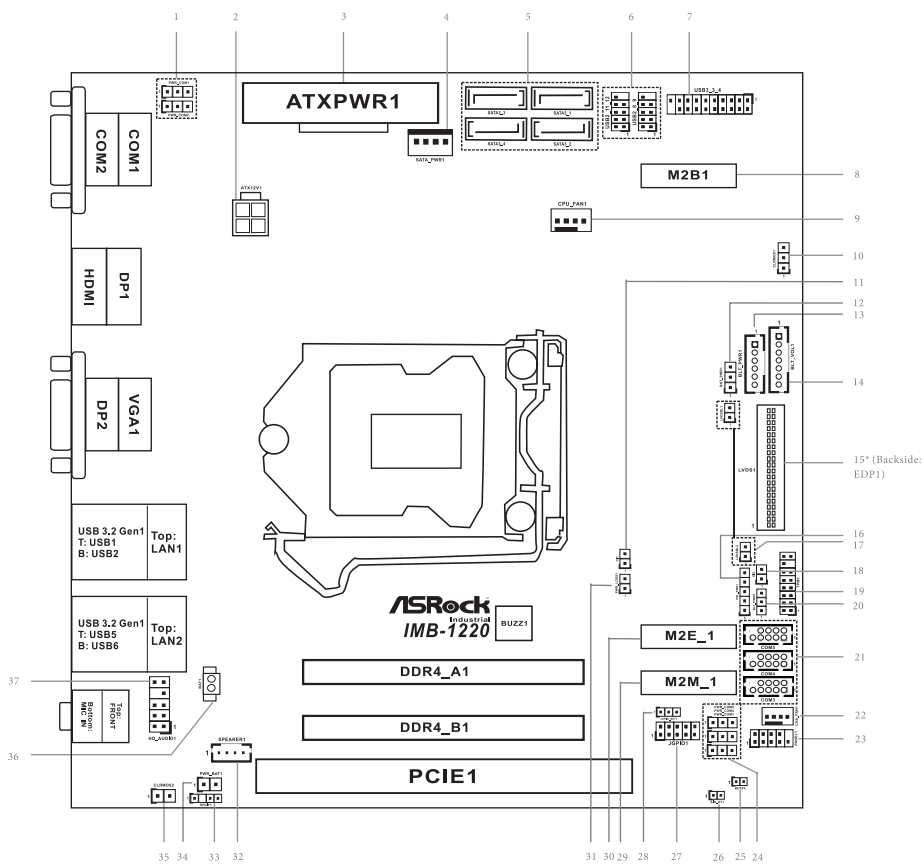

-
- 1 : COM Port PWR Setting Jumpers
 - PWR_COM1 (For COM Port1)
 - PWR_COM2 (For COM Port2)
 - 2 : 4-pin ATX Power Input/Output Connector
 - 3 : 24-pin ATX Power Input Connector
 - 4 : SATA Power Output Connector
 - 5 : SATA3 Connectors (SATA3_1~4)
 - 6 : USB2.0 Headers (USB2_8_9, USB2_11_12)
 - * USB2_11_12 is for IMB-1220 / IMB-X1220 only.
 - 7 : USB3.2 Gen1 Header (USB3_3_4)
 - 8 : M.2 Key-B Socket (M2B1)
 - 9 : 4-Pin CPU FAN Connector (+12V) (CPU_FAN1)
 - 10 : Clear CMOS Header (CLRMO1)
 - 11 : Chassis Intrusion Header (CI1)
 - 12 : Backlight Power Select (LCD_BLT_VCC) (BKT_PWR1)
 - 13 : Inverter Power Control Wafer (BLT_PWR1)
 - 14 : Backlight Volume Control (BLT_VOL1)
 - 15* : LVDS Panel Connector (IMB-1220-L)
 - * eDP Connector (on the Backside of PCB) (IMB-1220-D)
 - 16 : Panel Power Select (LCD_VCC) (PNL_PWR1)
 - 17 : LVDSBL1, LVDSBL2
 - 18 : Chassis Intrusion Header (CI2)
 - 19 : TPM Header (For IMB-1220 / IMB-X1220 Only)
 - 20 : Backlight Control Level (CON_LBKL_CTL) (BLT_PWM1)
 - 21 : COM Port Headers (COM3, 4, 5) (RS232)
 - * COM5 is for IMB-1220 / IMB-X1220 only.
 - 22 : 4-Pin Chassis FAN Connector (+12V)
 - 23 : System Panel Header
 - 24 : COM Port PWR Setting Jumpers
 - PWR_COM3 (For COM Port3)
 - PWR_COM4 (For COM Port4)
 - PWR_COM5 (For COM Port5) (For IMB-1220 / IMB-X1220 only)
 - 25 : Buzzer
 - 26 : SIO_AT1
 - 27 : Digital Input/Output Pin Header (JGPIO1)
 - 28 : Digital Input / Output Default Value Setting (JGPIO_SET1)
 - 29 : M.2 Key-M Socket (M2M_1)
 - 30 : M.2 Key-E Socket (M2E_1)
 - 31 : PWR LOSS Header (PWR_LOSS1)
 - 32 : 3W Audio AMP Output Wafer
 - 33 : SPDIF Header
 - 34 : PWR_BAT1
 - 35 : Clear CMOS Header (CLRMO2)
 - 36 : Battery Connector
 - 37 : Front Panel Audio Header

Back Side :

- SIM Card Socket (SIM1)
- eDP Connector (EDP1) (IMB-1220-D)
- MCU Connector (MCU_CON1)

1.4 I/O Panel

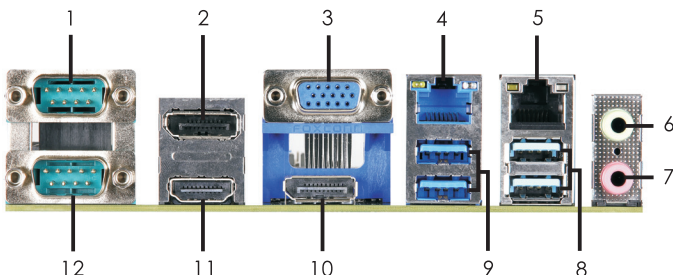

- | | |
|---|--|
| <ul style="list-style-type: none"> 1 COM Port (COM1) (RS232/422/485)* 2 DisplayPort (DP1) 3 D-Sub Port (VGA1) (IMB-1220-L Only) 4 LAN RJ-45 Port (LAN1)** 5 LAN RJ-45 Port (LAN2)*** 6 Line out (Lime) 7 Microphone (Pink) | <ul style="list-style-type: none"> 8 USB3.2 Gen1 Ports (USB_5_6) (IMB-1220 / IMB-X1220)
USB2.0 Ports (USB_5_6) (IMB-1221) 9 USB3.2 Gen1 Ports (USB_1_2) 10 DisplayPort (DP2) (IMB-1220-D Only) 11 HDMI Port (HDMI1) 12 COM Port (COM2) (RS232/422/485)* |
|---|--|

* This motherboard supports RS232/422/485 on COM1, 2 ports. Please refer to below table for the pin definition. In addition, COM1, 2 ports (RS232/422/485) can be adjusted in BIOS setup utility > Advanced Screen > Super IO Configuration. You may refer to page 34 for details.

COM1, 2 Port Pin Definition

PIN	RS232	RS422	RS485
1	DCD	TX-	RTX-
2	RXD	RX+	N/A
3	TXD	TX+	RTX+
4	DTR	RX-	N/A
5	GND	GND	GND
6	DSR	N/A	N/A
7	RTS	N/A	N/A
8	CTS	N/A	N/A
9	+5V / +12V	N/A	N/A

** There are two LED next to the LAN port. Please refer to the table below for the LAN port LED indications.

LAN Port LED Indications

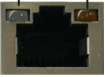
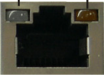
Activity/Link LED		SPEED LED		ACT/LINK LED	SPEED LED
Status	Description	Status	Description		
Off	No Link	Off	10Mbps connection		
Blinking	Data Activity	Orange	100Mbps/1Gbps connection		
On	Link	Green	2.5Gbps connection		

*** There are two LED next to the LAN port. Please refer to the table below for the LAN port LED indications.

LAN Port LED Indications

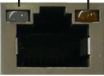
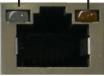
Activity/Link LED		SPEED LED		ACT/LINK LED	SPEED LED
Status	Description	Status	Description		
Off	No Link	Off	10Mbps connection		
Blinking	Data Activity	Orange	100Mbps connection		
On	Link	Green	1Gbps connection		

Chapter 2: Installation

This is a Mini-ITX form factor (6.7" x 6.7", 17.0 x 17.0 cm) motherboard. Before you install the motherboard, study the configuration of your chassis to ensure that the motherboard fits into it.



Make sure to unplug the power cord before installing or removing the motherboard. Failure to do so may cause physical injuries to you and damages to motherboard components.

2.1 Screw Holes

Place screws into the holes to secure the motherboard to the chassis.



Do not over-tighten the screws! Doing so may damage the motherboard.

2.2 Pre-installation Precautions

Take note of the following precautions before you install motherboard components or change any motherboard settings.

1. Unplug the power cord from the wall socket before touching any component.
2. To avoid damaging the motherboard components due to static electricity, NEVER place your motherboard directly on the carpet or the like. Also remember to use a grounded wrist strap or touch a safety grounded object before you handle components.
3. Hold components by the edges and do not touch the ICs.
4. Whenever you uninstall any component, place it on a grounded antistatic pad or in the bag that comes with the component.



Before you install or remove any component, ensure that the power is switched off or the power cord is detached from the power supply. Failure to do so may cause severe damage to the motherboard, peripherals, and/or components.

2.3 Installation of Memory Modules (SO-DIMM)

This motherboard provides two 260-pin DDR4 (Double Data Rate 4) SO-DIMM slots.



1. The SO-DIMM only fits in one correct orientation. It will cause permanent damage to the motherboard and the SO-DIMM if you force the SO-DIMM into the slot at incorrect orientation.
2. Please do not intermix different voltage SO-DIMMs on this motherboard.

1

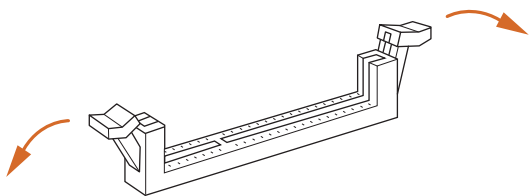

2

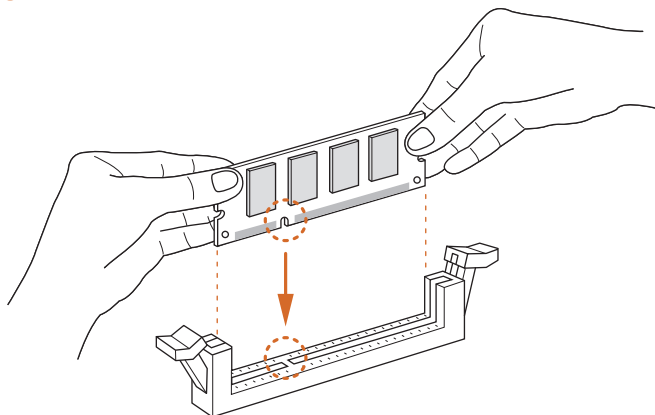

3

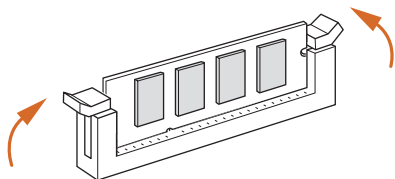

2.4 Expansion Slots

There are 3 M.2 sockets, 1 PCI Express slot and 1 SIM socket on this motherboard.

M.2 sockets:

- 1 x M.2 (Key E, 2230) with PCIe x1, USB 2.0 and CNVio for Wireless.
- 1 x M.2 (Key B, 3042) with PCIe1/USB3.0/USB2.0 and SIM for 4G/5G.
- 1 x M.2 (Key M, 2242/2260/2280) with PCIe4 (IMB-1220 / IMB-X1220) / PCIe2 (IMB-1221) and SATA3 for SSD.

PCIe slot: PCIe1 (PCIe 3.0 x16 slot) is used for PCI Express x16 lane width cards, support riser card x8/x8, x8/x4/x4.

SIM socket:

- 1 x SIM socket connected to M.2 key B

M.2 Socket Pin Definition:

M.2 Key-B Socket (M2B1)

Pin	Signal	Signal	Pin
1	NA	+3.3V	2
3	GND	+3.3V	4
5	GND	FULL_Card_Power_off	6
7	USB_D+	W_DISABLE	8
9	USB_D-	WWAN_LED#	10
11	GND		
21	GND	NA	20
23	NA	NA	22
25	NA	NA	24
27	GND	NA	26
29	USB3_RX-	NA	28
31	USB3_RX+	UIM_RESET	30
33	GND	UIM_CLK	32
35	USB3_TX-	UIM_DATA	34
37	USB3_TX+	UIM_PWR	36
39	GND	NA	38
41	PERn0	NA	40
43	PERp0	NA	42
45	GND	NA	44
47	PETn0	NA	46
49	PETp0	NA	48
51	GND	PERST#	50
53	PEFLCKn	CLKREQ#	52
55	PEFLCKp	WAKE#	54
57	GND	NA	56
59	NA	NA	58
61	NA	NA	60
63	NA	NA	62
65	NA	NA	64
67	NA	NA	66
69	NA	NA	68
71	GND	+3.3V	70
73	GND	+3.3V	72
75	NA	+3.3V	74

M.2 Key-M Socket (M2M_1)

Pin	Signal	Signal	Pin
1	GND	+3.3V	2
3	GND	+3.3V	4
5	PERn3	NA	6
7	PETp2	NA	8
9	GND	SATA_LED	10
11	PETn3	+3.3V	12
13	PETp3	+3.3V	14
15	GND	+3.3V	16
17	PERn2	+3.3V	18
19	PETp2	NA	20
21	GND	NA	22
23	PETn2	NA	24
25	PETp2	NA	26
27	GND	NA	28
29	PERn1	NA	30
31	PETp1	NA	32
33	GND	NA	34
35	PETn1	NA	36
37	PETp1	DEVSLP	38
39	GND	SMB_CLK	40
41	PERn0/SATA-B+	SMB_DATA	42
43	PETp0/SATA-B-	NA	44
45	GND	NA	46
47	PETn0/SATA-A-	NA	48
49	PETp0/SATA-A+	PERST#	50
51	GND	CLKREQ#	52
53	PEFLCKn	WAKE#	54
55	PEFLCKp	NA	56
57	GND	NA	58
67	NA	NA	68
69	PEDET	+3.3V	70
71	GND	+3.3V	72
73	GND	+3.3V	74
75	GND		

M.2 Key-E Socket (M2E_1)

Pin	Signal	Signal	Pin
1	GND	+3.3V	2
3	USB_D+	+3.3V	4
5	USB_D-	NA	6
7	GND	NA	8
9	CNV_WGR_D1-	CNV_RF_RESET	10
11	CNV_WGR_D1+	NA	12
13	GND	MODEM_CLKREQ	14
15	CNV_WGR_DD-	NA	16
17	CNV_WGR_DD+	GND	18
19	GND	NA	20
21	CNV_WGR_CLK	CNV_BRI_RSP	22
23	CNV_WGR_CLK+		
33	GND	CNV_BG1_DT	32
35	PETp	CNV_RQ1_RSP	34
37	PETn	CNV_BAI_DT	36
39	GND	NA	38
41	PERp	NA	40
43	PERn	NA	42
45	GND	NA	44
47	PEFLCK	NA	46
49	PEFLCK0	NA	48
51	GND	SUSCLK	50
53	CLKREQ#	PERST0#	52
55	WAKE#	W_DISABLE#	54
57	GND	W_DISABLE#	56
59	CNV_WT_D1-	SMB_DATA	58
61	CNV_WT_D1+	SMB_CLK	60
63	GND	NA	62
65	CNV_WT_DD-	CLKIN_XTAL_LCP	64
67	CNV_WT_DD+	NA	66
69	GND	NA	68
71	CNV_WT_CLK-	NA	70
73	CNV_WT_CLK+	+3.3V	72
75	GND	+3.3V	74

* For IMB-1221, if M2M_1 is occupied by a SATA-type M.2 device, SATA3_1 will be disabled.

2.5 Jumpers Setup

The illustration shows how jumpers are setup. When the jumper cap is placed on pins, the jumper is “Short”. If no jumper cap is placed on pins, the jumper is “Open”. The illustration shows a 3-pin jumper whose pin1 and pin2 are “Short” when jumper cap is placed on these 2 pins.

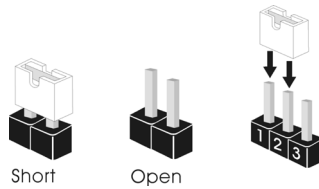

Jumper	Setting	Description
Clear CMOS Jumpers (3-pin CLRMOS1) (see p.9, No. 10)	<div style="display: flex; justify-content: space-around;"> <div style="text-align: center;"> <p>1_2</p> <p>Default</p> </div> <div style="text-align: center;"> <p>2_3</p> <p>Clear CMOS</p> </div> </div>	CLRMOS1 : 1-2 : Normal 2-3 : Clear CMOS

Note: CLRMOS1 allows you to clear the data in CMOS. To clear and reset the system parameters to default setup, please turn off the computer and unplug the power cord from the power supply. After waiting for 15 seconds, use a jumper cap to short pin2 and pin3 on CLRMOS1 for 5 seconds. However, please do not clear the CMOS right after you update the BIOS. If you need to clear the CMOS when you just finish updating the BIOS, you must boot up the system first, and then shut it down before you do the clear-CMOS action. Please be noted that the date, time and user default profile will be cleared only if the CMOS battery is removed.

(2-pin CLRMOS2) (see p.9, No. 35)		CLRMOS2 : Open : Normal Short : Auto Clear CMOS (Power Off)
--------------------------------------	--	---

Digital Input / Output Default Value Setting (3-pin JGPIO_SET1) (see p.9, No. 28)	<p>1 2 3</p>	1-2 : Pull-High 2-3 : Pull-Low
---	--------------	-----------------------------------

Backlight Power Select (LCD_BLT_VCC) (3-pin BKT_PWR1) (see p.9, No. 12)	<p>1 2 3</p>	1-2 : LCD_BLT_VCC : +5V 2-3 : LCD_BLT_VCC : +12V
---	--------------	---

PWR_BAT1 (2-pin PWR_BAT1) (see p.9, No. 34)		Open : Normal Short : Charge Battery
---	--	---

COM Port PWR Setting Jumpers

(3-pin PWR_COM1 (For COM Port1),
PWR_COM2 (For COM Port2))
(see p.9, No. 1)



1-2 : +5V
2-3 : +12V

(3-pin PWR_COM3 (For COM Port3),
PWR_COM4 (For COM Port4),
PWR_COM5 (For COM Port5) (For IMB-1220 / IMB-X1220 only))
(see p.9, No. 24)

Chassis Intrusion Headers

(2-pin CI1: see p.9, No. 11)
(2-pin CI2: see p.9, No. 18)

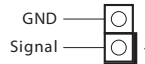

This motherboard supports
CASE OPEN detection feature
that detects if the chassis cover
has been removed. This feature
requires a chassis with chassis
intrusion detection design.

CI1 :
Close : Active Case Open
Open : Normal
CI2 :
Close : Normal
Open : Active Case Open

Panel Power Select (LCD_VCC)

(5-pin PNL_PWR1)
(see p.9, No. 16)



1-2 : LCD_VCC : +3V
2-3 : LCD_VCC : +5V
4-5 : LCD_VCC : +12V

LVDSBL1, LVDSBL2

(2-pin LVDSBL1, LVDSBL2)
(see p.9, No. 17)



LVDSBL1 :
Open : Protect LCD_VCC
Short : No Protect LCD_VCC
LVDSBL2 :
Open : Protect LCD_BLT_VCC
Short : No Protect LCD_BLT_VCC

Backlight Control Level (CON_LBKLT_CTL)

(3-pin BLT_PWM1)
(see p.9, No. 20)



1-2 : From eDP PWM to CON_LBKLT_CTL
2-3 : From LVDS PWM to CON_LBKLT_CTL

ATX/AT Mode Jumper

(2-pin SIO_AT1)

(see p.9, No. 26)



Open : ATX Mode

Short : AT Mode

PWR LOSS Header

(2-pin PWR_LOSS1)

(see p.9, No. 31)



Open : no Power Loss

Short : Power Loss

2.6 Onboard Headers and Connectors



Onboard headers and connectors are NOT jumpers. Do NOT place jumper caps over these headers and connectors. Placing jumper caps over the headers and connectors will cause permanent damage of the motherboard!

CPU Fan Connector (+12V)

(4-pin CPU_FAN1)

(see p.9 No. 9)

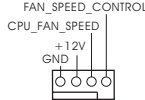

Please connect the CPU fan cable to the connector and match the black wire to the ground pin.



Though this motherboard provides 4-Pin CPU fan (Quiet Fan) support, the 3-Pin CPU fan still can work successfully even without the fan speed control function. If you plan to connect the 3-Pin CPU fan to the CPU fan connector on this motherboard, please connect it to Pin 1-3.

Chassis Fan Connector (+12V)

(4-pin CHA_FAN1)

(see p.9 No. 22)

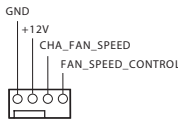

Please connect the chassis fan cable to the connector and match the black wire to the ground pin.



Though this motherboard provides 4-Pin chassis fan (Quiet Fan) support, the 3-Pin chassis fan still can work successfully even without the fan speed control function. If you plan to connect the 3-Pin chassis fan to the chassis fan connector on this motherboard, please connect it to Pin 1-3.

Digital Input / Output Pin Header

(10-pin JGPIO1)

(see p.9, No. 27)

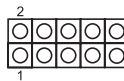

PIN	Signal Name	PIN	Signal Name	PIN	Signal Name	PIN	Signal Name	PIN	Signal Name
2	SIO_ GP71	4	SIO_ GP72	6	SIO_ GP73	8	SIO_ GP74	10	GND
1	SIO_ GP75	3	SIO_ GP76	5	SIO_ GP77	7	SIO_ GP80	9	JGPIO_ PWR

System Panel Header

(9-pin PANEL1)

(see p.9, No. 23)

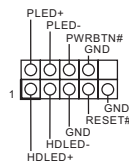

This header accommodates several system front panel functions.



Connect the power switch, reset switch and system status indicator on the chassis to this header according to the pin assignments below. Note the positive and negative pins before connecting the cables.

PWRBTN (Power Switch):

Connect to the power switch on the chassis front panel. You may configure the way to turn off your system using the power switch.

RESET (Reset Switch):

Connect to the reset switch on the chassis front panel. Press the reset switch to restart the computer if the computer freezes and fails to perform a normal restart.

PLED (System Power LED):

Connect to the power status indicator on the chassis front panel. The LED is on when the system is operating. The LED keeps blinking when the system is in S1/S3 sleep state. The LED is off when the system is in S4 sleep state or powered off (S5).

HDLED (Hard Drive Activity LED):

Connect to the hard drive activity LED on the chassis front panel. The LED is on when the hard drive is reading or writing data.

The front panel design may differ by chassis. A front panel module mainly consists of power switch, reset switch, power LED, hard drive activity LED, speaker and etc. When connecting your chassis front panel module to this header, make sure the wire assignments and the pin assignments are matched correctly.

COM3, 4, 5 Headers (RS232)

(COM5 is for IMB-1220 / IMB-X1220 only)



(9-pin COM3, 4, 5: see p.9, No. 21)

PIN	Signal Name	PIN	Signal Name	PIN	Signal Name	PIN	Signal Name	PIN	Signal Name
10	N/A	8	CCTS#	6	DDSR#	4	DDTR#	2	RRXD
9	PWR	7	RRTS#	5	GND	3	TTXD	1	DDCD#

SATA3 Connectors

(SATA3_1~4: see p.9, No. 5)

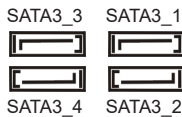

These four Serial ATA3 (SATA3) connectors support SATA data cables for internal storage devices. The current SATA3 interface allows up to 6.0 Gb/s data transfer rate.

* For IMB-1221, if M2M_1 is occupied by a SATA-type M.2 device, SATA3_1 will be disabled.

Buzzer

(2-pin BUZZ2)

(see p.9 No. 25)



Front Panel Audio Header

(9-pin HD_AUDIO1)

(see p.9 No. 37)

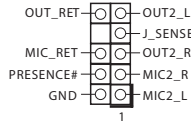

This is an interface for front panel audio cable that allows convenient connection and control of audio devices.



1. High Definition Audio supports Jack Sensing, but the panel wire on the chassis must support HDA to function correctly. Please follow the instruction in our manual and chassis manual to install your system.

2. If you use AC'97 audio panel, please install it to the front panel audio header as below:

- A. Connect Mic_IN (MIC) to MIC2_L.
- B. Connect Audio_R (RIN) to OUT2_R and Audio_L (LIN) to OUT2_L.
- C. Connect Ground (GND) to Ground (GND).
- D. MIC_RET and OUT_RET are for HD audio panel only. You don't need to connect them for AC'97 audio panel.
- E. To activate the front mic.

Go to the "FrontMic" Tab in the Realtek Control panel. Adjust "Recording Volume".

3W Audio AMP Output Wafer

(4-pin SPEAKER1)

(see p.9 No. 32)



PIN	Signal Name	PIN	Signal Name	PIN	Signal Name	PIN	Signal Name
1	OUTLN	2	OUTLP	3	OUTRP	4	OUTRN

SPDIF Header

(3-pin SPDIF1)

(see p.9, No. 33)

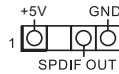

SPDIF header, providing SPDIF audio output to HDMI VGA card, allows the system to connect HDMI Digital TV/ projector/LCD devices. Please connect the SPDIF connector of HDMI VGA card to this header.

TPM Header (For IMB-1220 / IMB-X1220 Only)

(15-pin TPM1)

(see p.9, No. 19)

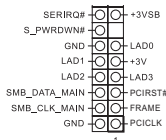

This connector supports a Trusted Platform Module (TPM) system, which can securely store keys, digital certificates, passwords, and data. A TPM system also helps enhance network security, protects digital identities, and ensures platform integrity.

ATX Power Input/Output Connector

(4-pin ATX12V1)

(see p.9 No. 2)

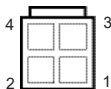

Please connect a DC

power supply to this

connector.

1-2 : GND
3-4 : DC Input

ATX Power Input Connector

(24-pin ATXPWR1)

(see p.9 No. 3)

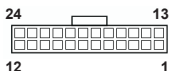

This motherboard provides

a 24-pin ATX power connector.

To use a 20-pin ATX power supply, please plug it along Pin 1 and Pin 13.

* LVDS Connector

(40-pin LVDS1)

(see p.9 No. 15)

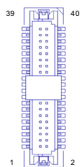

* PD (Panel Detection): Connect this pin to LVDS Panel's Ground pin to detect Panel detection.

PIN	Signal Name	PIN	Signal Name
39	LCD_BLT_VCC	40	LCD_BLT_VCC
37	CON_LBKLT_CTL	38	LCD_BLT_VCC
35	GND	36	CON_LBKLT_EN
33	LVDS_B_CLK#	34	LVDS_B_CLK
31	LVDS_B_DATA3	32	GND
29	DPLVDD_EN	30	LVDS_B_DATA3#
27	LVDS_B_DATA2#	28	LVDS_B_DATA2
25	LVDS_B_DATA1	26	GND
23	GND	24	LVDS_B_DATA1#
21	LVDS_B_DATA0#	22	LVDS_B_DATA0
19	LVDS_A_CLK	20	GND
17	GND	18	LVDS_A_CLK#
15	LVDS_A_DATA3#	16	LVDS_A_DATA3
13	LVDS_A_DATA2	14	GND
11	GND	12	LVDS_A_DATA2#
9	LVDS_A_DATA1#	10	LVDS_A_DATA1
7	LVDS_A_DATA0	8	PD (Panel Detection)
5	LDDC_DATA	6	LVDS_A_DATA0#
3	+3.3V	4	LDDC_CLK
1	LCD_VCC	2	LCD_VCC

eDP Connector

(on the Backside of PCB)

(40-pin EDP1)



40	NA
39	LCD_BLT_VCC
38	LCD_BLT_VCC
37	LCD_BLT_VCC
36	LCD_BLT_VCC
35	NA
34	NA
33	CON_LBKLT_CTL
32	CON_LBKLT_EN
31	GND
30	GND
29	GND
28	GND
27	eDP_HPD_CON
26	GND
25	GND
24	GND
23	GND
22	NA
21	LCD_VCC
20	LCD_VCC
19	LCD_VCC
18	LCD_VCC
17	GND
16	eDP_AUX#_CON
15	eDP_AUX_CON
14	GND
13	eDP_TX0_CON
12	eDP_TX#0_CON
11	GND
10	eDP_TX1_CON
9	eDP_TX#1_CON
8	GND
7	eDP_TX2_CON
6	eDP_TX#2_CON
5	GND
4	eDP_TX3_CON
3	eDP_TX#3_CON
2	GND
1	NA
PIN	Signal Name

USB 2.0 Headers

(9-pin USB2_8_9, USB2_11_12:

see p.9, No. 6)

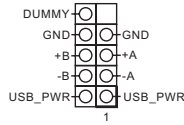

There are two headers on this motherboard. Each USB 2.0 header can support two ports.
* USB2_11_12 is for IMB-1220 / IMB-X1220 only

USB 3.2 Gen1 Header

(19-pin USB3_3_4:

see p.9, No. 7)

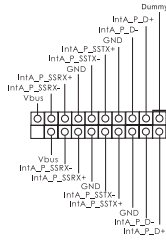

There are two headers on this motherboard. Each USB 3.2 Gen1 header can support two ports.

SATA Power Connector

(SATA_PWR1)

(see p.9 No. 4)



Please connect a SATA power cable to this connector.

Inverter Power Control Wafer

(6-pin BLT_PWR1)

(see p.9 No. 13)



PIN	Signal Name
1	GND
2	GND
3	CON_LBKLT_CTL
4	CON_LBKLT_EN
5	LCD_BLT_VCC
6	LCD_BLT_VCC

Backlight Volume Control

(7-pin BLT_VOL1)

(see p.9 No. 14)

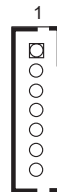

PIN	Signal Name
1	GPIO_VOL_UP
2	GPIO_VOL_DW
3	PWRDN
4	BLT_UP
5	BLT_DW
6	GND
7	GND

2.7 Installation of ROM Socket

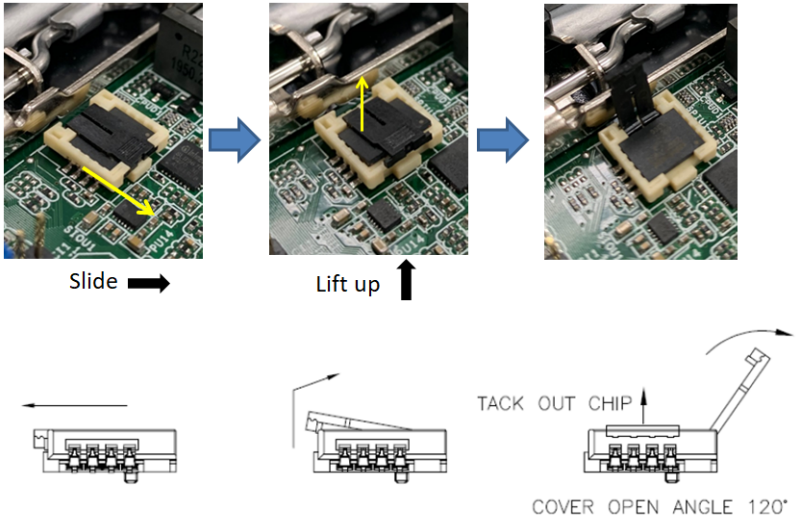

- *Do not apply force to the actuator cover after ic inserted.
- *Do not apply force to actuator cover when it is opening over 120 degree, Otherwise, the actuator cover may be broken.

Chapter 3: UEFI SETUP UTILITY

3.1 Introduction

This section explains how to use the UEFI SETUP UTILITY to configure your system. The UEFI chip on the motherboard stores the UEFI SETUP UTILITY. You may run the UEFI SETUP UTILITY when you start up the computer. Please press <F2> or during the Power-On-Self-Test (POST) to enter the UEFI SETUP UTILITY, otherwise, POST will continue with its test routines.

If you wish to enter the UEFI SETUP UTILITY after POST, restart the system by pressing <Ctl> + <Alt> + <Delete>, or by pressing the reset button on the system chassis. You may also restart by turning the system off and then back on.



Because the UEFI software is constantly being updated, the following UEFI setup screens and descriptions are for reference purpose only, and they may not exactly match what you see on your screen.

3.1.1 UEFI Menu Bar

The top of the screen has a menu bar with the following selections:

Main	To set up the system time/date information
Advanced	To set up the advanced UEFI features
H/W Monitor	To display current hardware status
Security	To set up the security features
Boot	To set up the default system device to locate and load the Operating System
Exit	To exit the current screen or the UEFI SETUP UTILITY

Use <←> key or <→> key to choose among the selections on the menu bar, and then press <Enter> to get into the sub screen. You can also use the mouse to click your required item.

3.1.2 Navigation Keys

Please check the following table for the function description of each navigation key.

Navigation Key(s)	Function Description
← / →	Moves cursor left or right to select Screens
↑ / ↓	Moves cursor up or down to select items
+ / -	To change option for the selected items
<Enter>	To bring up the selected screen
<F1>	To display the General Help Screen
<F7>	Discard changes
<F9>	To load optimal default values for all the settings
<F10>	To save changes and exit the UEFI SETUP UTILITY
<F12>	Print screen
<ESC>	To jump to the Exit Screen or exit the current screen

3.2 Main Screen

When you enter the UEFI SETUP UTILITY, the Main screen will appear and display the system overview.

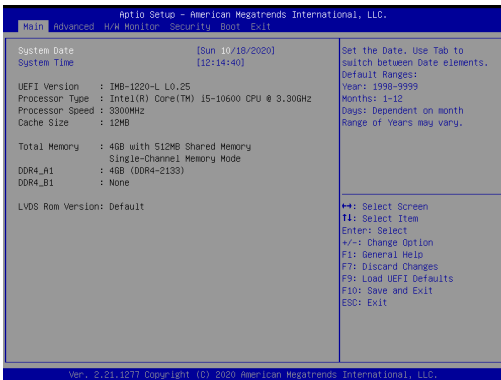

3.3 Advanced Screen

In this section, you may set the configurations for the following items: CPU Configuration, Chipset Configuration, Storage Configuration, Super IO Configuration, AMT Configuration, ACPI Configuration, USB Configuration and Trusted Computing.

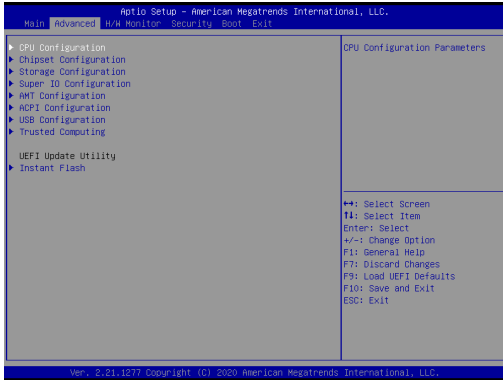

Setting wrong values in this section may cause the system to malfunction.

Instant Flash

Instant Flash is a UEFI flash utility embedded in Flash ROM. This convenient UEFI update tool allows you to update system UEFI without entering operating systems first like MS-DOS or Windows[®]. Just launch this tool and save the new UEFI file to your USB flash drive, floppy disk or hard drive, then you can update your UEFI only in a few clicks without preparing an additional floppy diskette or other complicated flash utility. Please be noted that the USB flash drive or hard drive must use FAT32/16/12 file system. If you execute Instant Flash utility, the utility will show the UEFI files and their respective information. Select the proper UEFI file to update your UEFI, and reboot your system after UEFI update process completes.

3.3.1 CPU Configuration

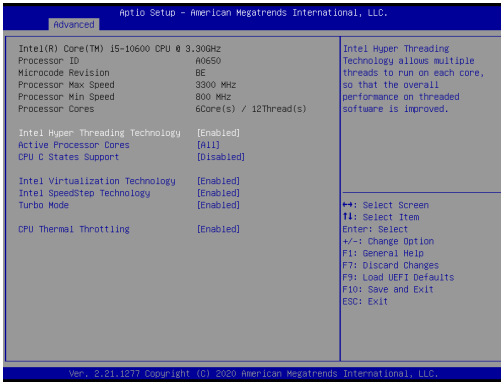

Intel Hyper Threading Technology

Intel Hyper Threading Technology allows multiple threads to run on each core, so that the overall performance on threaded software is improved.

Active Processor Cores

Select the number of cores to enable in each processor package.

CPU C States Support

Enable CPU C States Support for power saving. It is recommended to keep C3, C6 and C7 all enabled for better power saving.

Intel Virtualization Technology

When this option is set to [Enabled], a VMM (Virtual Machine Architecture) can utilize the additional hardware capabilities provided by Vanderpool Technology. This option will be hidden if the installed CPU does not support Intel Virtualization Technology.

Intel SpeedStep Technology

Intel SpeedStep technology is Intel's new power saving technology. Processors can switch between multiple frequencies and voltage points to enable power saving. The default value is [Enabled]. Configuration options: [Enabled] and [Disabled]. If you install Windows® OS and want to enable this function, please set this item to [Enabled]. This item will be hidden if the current CPU does not support Intel SpeedStep technology.



Please note that enabling this function may reduce CPU voltage and lead to system stability or compatibility issues with some power supplies. Please set this item to [Disabled] if above issues occur.



Turbo Mode

Use this item to enable or disable Intel Turbo Boost Mode Technology. Turbo Boost Mode allows processor cores to run faster than marked frequency in specific conditions. The default value is [Enabled].

CPU Thermal Throttling

You may select [Enabled] to enable CPU internal thermal control mechanism to keep the CPU from overheating.



3.3.2 Chipset Configuration

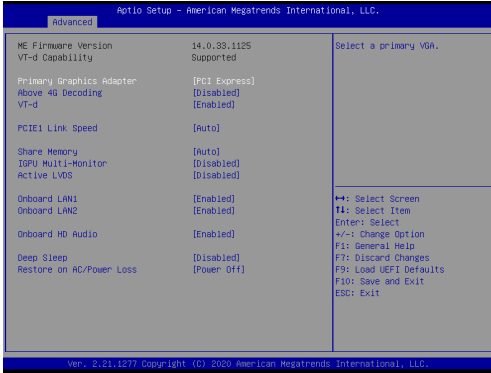

Primary Graphics Adapter

This allows you to select [Onboard] or [PCI Express] as the boot graphic adapter priority. The default value is [PCI Express].

Above 4G Decoding

Enable or disable 64bit capable Devices to be decoded in Above 4G Address Space (only if the system supports 64 bit PCI decoding).

VT-d

Use this to enable or disable Intel® VT-d technology (Intel® Virtualization Technology for Directed I/O). The default value of this feature is [Disabled].

PCIE1 Link Speed

Select the link speed for PCIE1.

Share Memory

Configure the size of memory that is allocated to the integrated graphics processor when the system boots up.

IGPU Multi-Monitor

Select disable to disable the integrated graphics when an external graphics card is installed. Select enable to keep the integrated graphics enabled at all times.

Active LVDS

Use this to enable or disable the LVDS. The default value is [Disabled]. Set the item to [enable]. Then press <F10> to save the setting and restart the system. Now the default value of Active LVDS is changed to ENABLE (F9 load default is also set to ENABLE)

Change the setting from [Enable] to [Disable], and then press <F10> to save the setting and restart the system. Likewise, the default value of Active LVDS is changed to DISABLE (F9 load default is also set to DISABLE)

Panel Type Selection

Use this to select panel type. This item appears when you enable Active LVDS.



The default values of Active LVDS and Panel Type Selection will be changed only when the users manually adjust them. They will keep at the default values no matter you clear CMOS, use Instant Flash or press <F9>.

Onboard LAN1

This allows you to enable or disable the Onboard LAN1 feature.

Onboard LAN2

This allows you to enable or disable the Onboard LAN2 feature.

Onboard HD Audio

Select [Enabled] or [Disabled] for the onboard HD Audio feature.

Deep Sleep

Mobile platforms support Deep S4/S5 in DC only and desktop platforms support Deep S4/S5 in AC only. The default value is [Disabled].

Restore on AC/Power Loss

Select the power state after a power failure. If [Power Off] is selected, the power will remain off when the power recovers. If [Power On] is selected, the system will start to boot up when the power recovers.

3.3.3 Storage Configuration

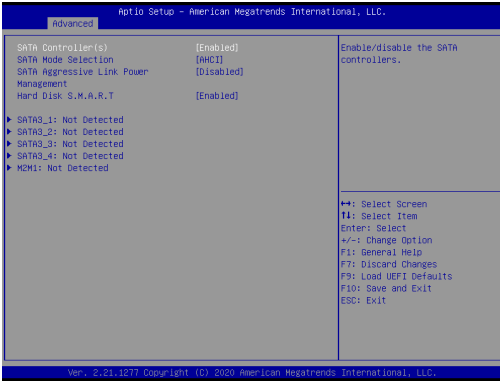

SATA Controller(s)

Use this item to enable or disable the SATA Controller feature.

SATA Mode Selection

Use this to select SATA mode. The default value is [AHCI Mode].



AHCI (Advanced Host Controller Interface) supports NCQ and other new features that will improve SATA disk performance.

SATA Aggressive Link Power Management

Use this item to configure SATA Aggressive Link Power Management.

Hard Disk S.M.A.R.T.

Use this item to enable or disable the S.M.A.R.T. (Self-Monitoring, Analysis, and Reporting Technology) feature. Configuration options: [Disabled] and [Enabled].

3.3.4 Super IO Configuration



COM1 Configuration

Use this to set parameters of COM1.

Type Select

Use this to select COM3 port type: [RS232], [RS422] or [RS485].

COM2 Configuration

Use this to set parameters of COM2.

Type Select

Use this to select COM3 port type: [RS232], [RS422] or [RS485].

COM3 Configuration

Use this to set parameters of COM3. Select COM3 port type: [RS232], [RS422] or [RS485].

COM4 Configuration

Use this to set parameters of COM4. Select COM4 port type: [RS232], [RS422] or [RS485].

COM5 Configuration (For IMB-1220 / IMB-X1220 only)

Use this to set parameters of COM5.

WDT Timeout Reset

Use this to set the Watch Dog Timer.

3.3.5 AMT Technology (For IMB-1220 / IMB-X1220 Only)

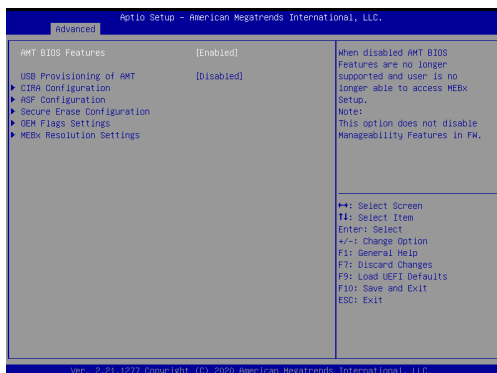

AMT BIOS Features

Use this to enable or disable Intel(R) Active Management Technology BIOS Extension. The default is [Enabled].

ASF support

Use this to enable or disable Alert Specification Format. The default is [Enabled].

USB Provisioning of AMT

Use this to enable or disable AMT USB Provisioning. The default is [Enabled].

Secure Erase mode

Change Secure Erase module behavior: Simulated: Performs SE flow without erasing SSD. Real: Erase SSD.

Force Secure Erase

Use this to enable or disable Force Secure Erase on next boot. The default is [Disabled].

MEBx hotkey Pressed

Use this to enable or disable MEBx hotkey press. The default is [Disabled].

MEBx Selection Screen

Use this to enable or disable MEBx Selection Screen. The default is [Disabled].

Hide Un-configure ME Confirmation Prompt

Hide Un-Configure ME without password confirmation prompt. The default is [Disabled].

MEBx OEM Debug Menu Enable

Use this to enable or disable MEBx OEM Debug Menu. The default is [Disabled].

Un-Configure ME

Un-Configure ME without password. The default is [Disabled].

WatchDog

Use this to enable or disable AMT WatchDog Timer. The default is [Disabled].

Activate Remote Assistance Process

Trigger CIRA boot. The default is [Disabled].

PET Progress

User can enable or disable PET Events progress to receive PET events or not. The default is [Enabled].

ASF Sensors Table

Use this to enable or disable ASF Sensor Table. The default is [Disabled].

Non-UI Mode Resolution

Use this to set resolution for non-UI text mode.

UI Mode Resolution

Use this to set resolution for UI text mode.

Graphics Mode Resolution

Use this to set resolution for graphics mode.

3.3.6 ACPI Configuration

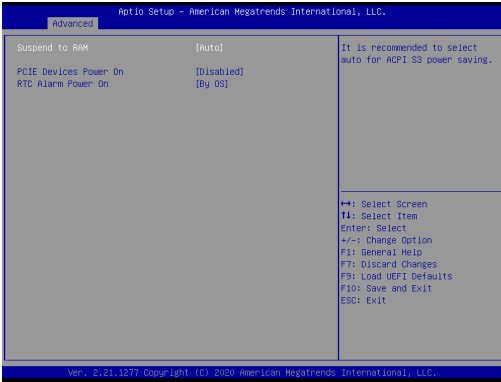

Suspend to RAM

Use this item to select whether to auto-detect or disable the Suspend-to-RAM feature. Select [Auto] will enable this feature if the OS supports it.

PCIe Devices Power On

Use this item to enable or disable PCIe devices to turn on the system from the power-soft-off mode.

RTC Alarm Power On

Use this item to enable or disable RTC (Real Time Clock) to power on the system.

3.3.7 USB Configuration



Legacy USB Support

Use this option to select legacy support for USB devices. There are two configuration options: [Enabled] and [UEFI Setup Only]. The default value is [Enabled]. Please refer to below descriptions for the details of these two options:

[Enabled] - Enables support for legacy USB.

[UEFI Setup Only] - USB devices are allowed to use only under UEFI setup and Windows / Linux OS.

USB Power Control

Use this option to control USB power.

3.3.8 Trusted Computing (For IMB-1220 / IMB-X1220 Only)



Security Device Support

Enable or disable BIOS support for security device.

Onboard TPM

Use this to enable or disable onboard TPM. The default is [Enabled].

3.4 Hardware Health Event Monitoring Screen

In this section, it allows you to monitor the status of the hardware on your system, including the parameters of the CPU temperature, motherboard temperature, CPU fan speed, chassis fan speed, and the critical voltage.

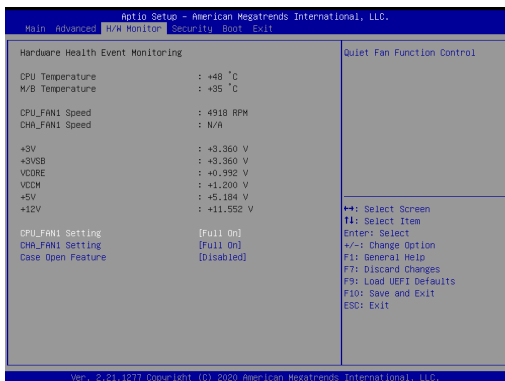

CPU_FAN1 Setting

This allows you to set CPU fan 1's speed. Configuration options: [Full On] and [Automatic Mode]. The default value is [Full On].

CHA_FAN1 Setting

This allows you to set chassis fan 1's speed. Configuration options: [Full On] and [Automatic Mode]. The default value is [Full On].

Case Open Feature

This allows you to enable or disable case open detection feature. The default is value [Disabled].

Clear Status

This option appears only when the case open has been detected. Use this option to keep or clear the record of previous chassis intrusion status.

3.5 Security Screen

In this section, you may set, change or clear the supervisor/user password for the system.

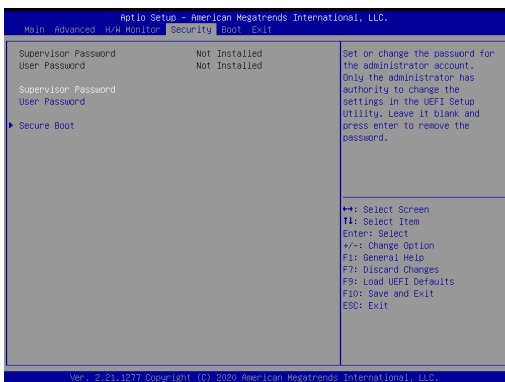

Supervisor Password

Set or change the password for the administrator account. Only the administrator has authority to change the settings in the UEFI Setup Utility. Leave it blank and press enter to remove the password.

User Password

Set or change the password for the user account. Users are unable to change the settings in the UEFI Setup Utility. Leave it blank and press enter to remove the password.

Secure Boot

Use this item to enable or disable support for Secure Boot.

Intel(R) Platform Trust Technology

Enable/disable Intel PTT in ME. Disable this option to use discrete TPM Module.

3.6 Boot Screen

In this section, it will display the available devices on your system for you to configure the boot settings and the boot priority.

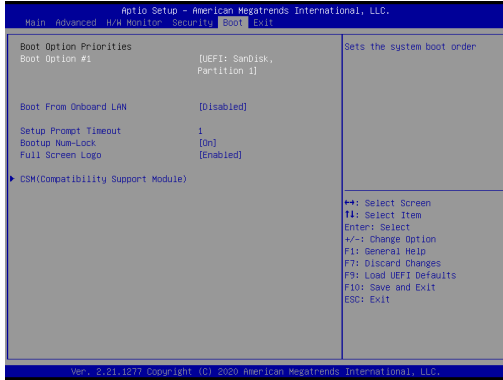

Boot From Onboard LAN

Use this item to enable or disable the Boot From Onboard LAN feature.

Setup Prompt Timeout

This shows the number of seconds to wait for setup activation key. 65535(0xFFFF) means indefinite waiting.

Bootup Num-Lock

If this item is set to [On], it will automatically activate the Numeric Lock function after boot-up.

Full Screen Logo

Use this item to enable or disable OEM Logo. The default value is [Disabled].

CSM (Compatibility Support Module)

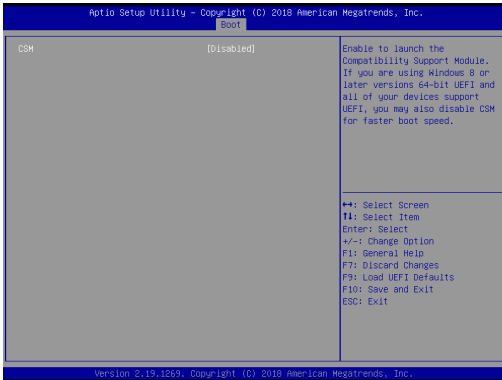

CSM

Use this to enable or disable Compatibility Support Module. The default value is [Disabled].

Launch PXE OpROM Policy

Select UEFI only to run those that support UEFI option ROM only. Select Legacy only to run those that support legacy option ROM only. Select Do not launch to not execute both legacy and UEFI option ROM.

Launch Storage OpROM Policy

Select UEFI only to run those that support UEFI option ROM only. Select Legacy only to run those that support legacy option ROM only. Select Do not launch to not execute both legacy and UEFI option ROM.

3.7 Exit Screen



Save Changes and Exit

When you select this option, it will pop-out the following message, "Save configuration changes and exit setup?" Select [OK] to save the changes and exit the UEFI SETUP UTILITY.

Discard Changes and Exit

When you select this option, it will pop-out the following message, "Discard changes and exit setup?" Select [OK] to exit the UEFI SETUP UTILITY without saving any changes.

Discard Changes

When you select this option, it will pop-out the following message, "Discard changes?" Select [OK] to discard all changes.

Load UEFI Defaults

Load UEFI default values for all the setup questions. F9 key can be used for this operation.

Launch EFI Shell from filesystem device

Attempts to Launch EFI Shell application (Shell64.efi) from one of the available filesystem devices.

Chapter 4: Software Support

4.1 Install Operating System

This motherboard supports various Microsoft® Windows® operating systems: 10 64-bit. Because motherboard settings and hardware options vary, use the setup procedures in this chapter for general reference only. Refer your OS documentation for more information.

4.2 Support CD Information

The Support CD that came with the motherboard contains necessary drivers and useful utilities that enhance the motherboard's features.

4.2.1 Running The Support CD

To begin using the support CD, insert the CD into your CD-ROM drive. The CD automatically displays the Main Menu if "AUTORUN" is enabled in your computer. If the Main Menu did not appear automatically, locate and double click on the file "ASRSETUP.EXE" from the BIN folder in the Support CD to display the menus.

4.2.2 Drivers Menu

The Drivers Menu shows the available device's drivers if the system detects installed devices. Please install the necessary drivers to activate the devices.

4.2.3 Utilities Menu

The Utilities Menu shows the application software that the motherboard supports. Click on a specific item then follow the installation wizard to install it.

4.2.4 Contact Information

If you need to contact ASRockInd or want to know more about ASRockInd, you're welcome to visit ASRockInd's website at <http://www.asrockind.com>; or you may contact your dealer for further information.